

METRIC/SI (ENGLISH)



NASA TECHNICAL STANDARD

NASA-STD-5020B

Office of the NASA Chief Engineer

Approved: 2021-08-06
Superseding NASA-STD-5020A
w/Change 1

**REQUIREMENTS FOR THREADED FASTENING
SYSTEMS IN SPACEFLIGHT HARDWARE**

APPROVED FOR PUBLIC RELEASE – DISTRIBUTION IS UNLIMITED

NASA-STD-5020B

DOCUMENT HISTORY LOG

Status	Document Revision	Change Number	Approval Date	Description
Baseline			2012-03-12	Initial Release
Revision	A		2018-09-04	<p>Significant changes were made to this NASA Technical Standard. It is recommended that it be reviewed in its entirety before implementation.</p> <p>Key changes were: The format of the baseline version has been modified to provide better flow of the requirements language. This includes the order of the requirements from the baseline version. Some requirements have been merged due to redundancy or deleted.</p>
		1	2019-02-11	<p>Editorial Changes—Corrected decision box No. 2 in Appendix A.5, Figure 8, Determining Whether a Joint Separates before Rupture When Loaded Solely in Tension, to state $P_{p-max} \leq 0.75 * P_{tu-allow}$ (vs. “0.85”), which aligns with the previous revision and the justification in the text. Corrected the symbol for phi to ϕ (vs. (φ) in equation 47. Unbolded two equations in Appendix A.12.3.</p>
Revision	B		2021-08-06	<p>Limited Revision: Changed NASA-STD-6008 to NASA-STD-8739.14, NASA Fastener Procurement, Receiving Inspection, and Storage Practices for NASA Mission Hardware, in sections 2.2 and 4.8.6. Also corrected Table 4, (Eq. 75), text associated with (Eq. 24), equation references in Figure 14 and 15, and logic in bullet list in Appendix C.2.</p>

APPROVED FOR PUBLIC RELEASE – DISTRIBUTION IS UNLIMITED

NASA-STD-5020B

FOREWORD

This NASA Technical Standard is published by the National Aeronautics and Space Administration (NASA) to provide uniform engineering and technical requirements for processes, procedures, practices, and methods that have been endorsed as standard for NASA programs and projects, including requirements for selection, application, and design criteria of an item.

This NASA Technical Standard is approved for use by NASA Headquarters and NASA Centers and Facilities, and applicable technical requirements may be cited in contract, program, and other Agency documents. It may also apply to the Jet Propulsion Laboratory (a Federally Funded Research and Development Center [FFRDC]), other contractors, recipients of grants and cooperative agreements, and parties to other agreements only to the extent specified or referenced in applicable contracts, grants, or agreements.

This NASA Technical Standard establishes criteria for ensuring the integrity of threaded fastening systems in launch and space vehicles and their associated equipment.

Requests for information should be submitted via “Feedback” at <https://standards.nasa.gov>. Requests for changes to this NASA Technical Standard should be submitted via Marshall Space Flight Center (MSFC) Form 4657, Change Request for a NASA Engineering Standard.

Original Signed by Adam West for

August 6, 2021

Ralph R. Roe, Jr.
NASA Chief Engineer

Approval Date

APPROVED FOR PUBLIC RELEASE – DISTRIBUTION IS UNLIMITED

NASA-STD-5020B

TABLE OF CONTENTS

<u>SECTION</u>	<u>PAGE</u>
DOCUMENT HISTORY LOG	2
FOREWORD	3
TABLE OF CONTENTS	4
LIST OF APPENDICES	5
LIST OF FIGURES	6
LIST OF TABLES	7
1. SCOPE	9
1.1 Purpose.....	9
1.2 Applicability.....	9
1.3 Tailoring.....	9
2. APPLICABLE DOCUMENTS	10
2.1 General	10
2.2 Government Documents	10
2.3 Non-Government Documents	10
2.4 Order of Precedence.....	11
3. ACRONYMS, ABBREVIATIONS, SYMBOLS, AND DEFINITIONS	11
3.1 Acronyms, Abbreviations, and Symbols.....	11
3.2 Definitions.....	12
3.2.1 Definition of Variables.....	12
3.2.2 Definition of Terms.....	14
4. REQUIREMENTS	16
4.1 Fastening System Control Plan	17
4.2 Design Factors.....	17
4.3 Fastening System Preload	20
4.4 Strength Requirements	26
4.5 Fatigue Life	36
4.6 Locking Features	37
4.7 Part Selection Criteria	40
4.8 Quality Assurance	42

APPROVED FOR PUBLIC RELEASE – DISTRIBUTION IS UNLIMITED

NASA-STD-5020B

LIST OF APPENDICES

<u>APPENDIX</u>	<u>PAGE</u>
A. EXPLANATION AND JUSTIFICATION OF FASTENER ANALYSIS CRITERIA	46
A.1 Purpose of Appendix A	46
A.2 Accounting for Preload Variation when Installing Fasteners with Torque Control (Supplement to Section 4.3.1)	46
A.3 Short-Term Relaxation of Preload (Supplement to Section 4.3.1)	51
A.4 Use of a Load-Introduction and Stiffness Factor (Supplement to Sections 4.4.1 and 4.4.2)	51
A.5 Bolt Analysis: Separation before Rupture (Supplement to Section 4.4.5).	60
A.6 Ultimate Margin of Safety for Tensile Loading with Linear Theory (Supplement to Section 4.4.1)	64
A.7 Omission of Preload in Shear and Interaction Analyses (Supplement to Sections 4.4.1 and 4.4.4)	65
A.8 Theoretical Treatment of Interaction Equations (Supplement to Section 4.4.4)	66
A.9 Determining if Fastener Yielding is Detrimental for Separation or Joint Slip (Supplement to Section 4.4.2)	70
A.10 Margin of Safety for Joint Slip (Supplement to Sections 4.4.1 and 4.4.6) ..	73
A.11 Margin of Safety for Bolted Joint Separation (Supplement to Section 4.4.3)	75
A.12 Load Redistribution within a Fastened Joint	75
B. BEST PRACTICES FOR LOCKING FEATURES	83
B.1 Purpose of Appendix B	83
B.2 Background and Introduction	83
B.3 Best Practices for Mechanical Locking Features	84
B.4 Best Practices for Prevailing Torque Locking Features	85
B.4.1 General	85
B.4.2 Prevailing Torque Locking Devices	86
B.4.3 Inspect	89
B.4.4 Installation and Verification	90
B.5 Best Practices for Adhesive Locking Features	90
B.5.1 Adhesives	90
B.5.2 Process Validation	92
B.5.3 Inspect	94
B.5.4 Clean	94
B.5.5 Prime (for anaerobic adhesives only)	94
B.5.6 Installation	94

APPROVED FOR PUBLIC RELEASE – DISTRIBUTION IS UNLIMITED

NASA-STD-5020B

LIST OF APPENDICES (Continued)

<u>APPENDIX</u>		<u>PAGE</u>
B.5.7	Verification	95
B.5.8	General.....	95
B.6	Best Practices for Free Spinning.....	96
C.	JUSTIFICATION FOR LOW LIKELIHOOD OF FATIGUE FAILURE	
	FAILURE	97
C.1	Purpose of Appendix C.....	97
C.2	Justification.....	97
D.	REFERENCES	101
D.1	Purpose of Appendix D	101
D.2	Reference Documents	101
E.	REQUIREMENTS COMPLIANCE MATRIX	106
E.1	Purpose of Appendix E.....	106

LIST OF FIGURES

<u>FIGURE</u>		<u>PAGE</u>
1	Logic Flow for Minimum Separation Factor of Safety.....	20
2	Dimensional Considerations in Selecting Fastening Hardware	41
3	Dimensions Used to Calculate the Geometric Load-Introduction Factor.....	53
4	Preloaded Joint Represented by Springs	54
5	Preloaded Joint Represented by Two Springs in Parallel	55
6	Geometric Load-Introduction Factor	58
7	Predicting the Product $n\phi$ from Finite Element Analysis	59
8	Determining Whether a Joint Separates before Rupture When Loaded Solely in Tension.....	60
9	How to Quantify Ductility of a Fastening System from a Tension Test.....	61
10	Preloaded Joint in which the Bolt Load Increases by a Relatively High Percentage of Applied Tensile Load	62
11	Separation before Rupture for a Brittle Threaded Fastening System ..	63
12	Separation before Rupture for a Ductile Threaded Fastening System.	63

APPROVED FOR PUBLIC RELEASE – DISTRIBUTION IS UNLIMITED

NASA-STD-5020B

LIST OF FIGURES (Continued)

<u>FIGURE</u>		<u>PAGE</u>
13	Bolt Tensile Load versus Applied Tensile Load	64
14	Separation before Rupture with Linear Theory	64
15	Rupture before Separation with Linear Theory	65
16	Stress Distribution at Collapse due to Combined Bending and Tension.....	68
17	Comparison of Interaction between Circular and Rectangular Cross Sections at Collapse	69
18	Effect of Fastener Yielding on the Separation Load.....	71
19	Loss of Preload Resulting from Fastener Yielding.....	72
20	Fastener Yielding under an Applied Load that Exceeds the Separation Load	73
21a	Lug with Clearance Holes Example	76
21b	Rigid Body Response for Lug with Clearance Holes	76
22a	Simplified Two-Bolt Plasticity Model.....	77
22b	Assumed Plasticity Model	77
23	Difference in Response between Elastic and Elastic-Plastic Model....	78
24	Two-Joint Separation Model	78
25	Bolt Forces during Loading of Two-Joint Separation Model.....	80
26	System Stiffness Due to Separation and Yielding	80
27	Shear Load Acting on Bolt from Slip Analysis	81
28	Contact Status at the Faying Surface during Slip	82
29	Locking Feature Selection Flowchart	85

LIST OF TABLES

<u>TABLE</u>		<u>PAGE</u>
1	Analytical Adjustments of Maximum and Minimum Preloads	22
2	Nominal Preload Determination	24
3	Preload Variation Determination	25
4	Locking Feature Torque Verification.....	39
5	Two-Sided 90/95 Tolerance Limit Factors for a Normal Distribution (Odeh and Owen, 1980)	49
6	Sample Data from 30 Torque-Tension Tests (Actual Test Data)	49

APPROVED FOR PUBLIC RELEASE – DISTRIBUTION IS UNLIMITED

NASA-STD-5020B

LIST OF TABLES (Continued)

<u>TABLE</u>		<u>PAGE</u>
7	Hypothetical Enveloped Applied-Loading Spectrum for Fastener Fatigue.....	98
8	Results of Fastener Fatigue Analysis for the Hypothetical Joint and Loading Spectra	100

REQUIREMENTS FOR THREADED FASTENING SYSTEMS IN SPACEFLIGHT HARDWARE

1. SCOPE

1.1 Purpose

The purpose of this NASA Technical Standard is to specify requirements for design and analysis of threaded fastening systems in NASA spaceflight hardware.

1.2 Applicability

This NASA Technical Standard is applicable to all NASA programs and projects. This NASA Technical Standard may not be applicable to Ground Support Equipment (GSE); NASA Technical Standard NASA-STD-5005, Standard for the Design and Fabrication of Ground Support Equipment, is applicable to GSE. Additional requirements for fracture control, non-metallic structures, non-standard fasteners, and fasteners used in extravehicular activity (EVA) may apply.

This NASA Technical Standard is approved for use by NASA Headquarters and NASA Centers and Facilities, and applicable technical requirements may be cited in contract, program, and other Agency documents. It may also apply to the Jet Propulsion Laboratory (a Federally Funded Research and Development Center [FFRDC]), other contractors, recipients of grants and cooperative agreements, and parties to other agreements only to the extent specified or referenced in applicable contracts, grants, or agreements.

Verifiable requirement statements are designated by the acronym “TFSR” (Threaded Fastening Systems Requirement), numbered, and indicated by the word “shall”; this NASA Technical Standard contains 32 requirements. Explanatory or guidance text is indicated in italics beginning in section 4. To facilitate requirements selection by NASA programs and projects, a Requirements Compliance Matrix is provided in Appendix E.

1.3 Tailoring

Document tailoring of the requirements in this NASA Technical Standard for application to a specific program or project as part of program or project requirements and obtain formal approval by the delegated Technical Authority in accordance with NPR 7120.5, NASA Space Flight Program and Project Management Requirements.

NASA-STD-5020B

2. APPLICABLE DOCUMENTS

2.1 General

The documents listed in this section contain provisions that constitute requirements of this NASA Technical Standard as cited in the text.

2.1.1 The latest issuances of cited documents apply unless specific versions are designated.

2.1.2 Non-use of a specifically designated version is approved by the delegated Technical Authority.

Applicable documents may be accessed at <https://standards.nasa.gov> or obtained directly from the Standards Developing Body or other document distributors. When not available from these sources, information for obtaining the document is provided.

2.2 Government Documents

National Aeronautics and Space Administration (NASA)

NPR 7120.5 NASA Space Flight Program and Project Management Requirements

NASA-STD-6016 Standard Materials and Processes Requirements for Spacecraft

NASA-STD-8739.14 NASA Fastener Procurement, Receiving Inspection, and Storage Practices for NASA Mission Hardware

2.3 Non-Government Documents

American Society of Mechanical Engineers (ASME)

ASME B107.300- Torque Instruments
2010

National Aerospace Standard (Metric) (NASM)

NASM 1312-15 Fastener Test Methods, Method 15, Torque-Tension

References are provided in Appendix D.

APPROVED FOR PUBLIC RELEASE – DISTRIBUTION IS UNLIMITED

NASA-STD-5020B

2.4 Order of Precedence

2.4.1 The requirements and standard practices established in this NASA Technical Standard do not supersede or waive existing requirements and standard practices found in other Agency documentation, or in applicable laws and regulations unless a specific exemption has been obtained by the Office of the NASA Chief Engineer.

2.4.2 Conflicts between this NASA Technical Standard and other requirements documents are resolved by the delegated Technical Authority.

3. ACRONYMS, ABBREVIATIONS, SYMBOLS, AND DEFINITIONS

3.1 Acronyms, Abbreviations, and Symbols

°C	degrees Celsius
°F	degrees Fahrenheit
/	divided by
>	greater than
≤	less than or equal to
%	percent
π	pi
+	plus
±	plus or minus
√	square root
AC	Advisory Circular
AND	Air Force-Navy aeronautical design
ASME	The American Society of Mechanical Engineers
CRES	corrosion-resistant steel
dB	decibel
Eq.	equation
EVA	extravehicular activity
FAA	Federal Aviation Administration
FEA	finite element analysis
FFRDC	Federally Funded Research and Development Center
GSE	ground support equipment
HDBK	Handbook
Hz	Hertz
in	inch(es)
ksi	kilopound per square inch
lb	Pound(s)
LIF	load-introduction factor
MEK	Methyl ethyl ketone
MIL	Military
MSFC	Marshall Space Flight Center

APPROVED FOR PUBLIC RELEASE – DISTRIBUTION IS UNLIMITED

NASA-STD-5020B

NAS	National Aerospace Standard
NASA	National Aeronautics and Space Administration
NASM	National Aerospace Standard (Metric)
NPR	NASA Procedural Requirements
NSTS	National Space Transportation System
PWA	Printed wiring assembly
SAE	Society of Automotive Engineers
SI	Système International
STD	Standard
T	nominal effective torque
TFSR	Threaded Fastening Systems Requirement

3.2 Definitions

3.2.1 Definition of Variables

Γ	uncertainty or scatter in initial preload
Γ_{a-max}	actual preload variation for maximum preload, as determined from a sample of torque-tension test data
Γ_{a-min}	actual preload variation for minimum preload, as determined from a sample of torque-tension test data
ϕ	stiffness factor
μ	coefficient of friction
τ	shear stress
σ	axial (tension) stress
σ	stress tensor
σ_{pi}	unbiased sample standard deviation
A	area
A_m	minimum minor-diameter area
c_{max}	a factor that accounts for the maximum value of the fastener's controlled installation parameter (e.g., effective torque), as allowed by the specified tolerance
c_{min}	a factor that accounts for the minimum value of the fastener's controlled installation parameter (e.g., effective torque), as allowed by the specified tolerance
D	nominal fastener diameter
f_{bu}	design ultimate bending stress based on linear-elastic theory
F_{bu}	allowable ultimate flexural stress (bending)
FF	fitting factor
F_{pre}	preloaded bolts
FS_{sep}	factor of safety for separation
F_{su}	allowable ultimate shear stress
FS_u	ultimate factor of safety
F_{sy}	allowable yield shear stress
FS_y	yield factor of safety

APPROVED FOR PUBLIC RELEASE – DISTRIBUTION IS UNLIMITED

NASA-STD-5020B

F_{tu}	allowable ultimate tensile stress
F_{ty}	allowable yield tensile stress
j	test number
k_b	stiffness of the bolt
k_c	stiffness of the clamped parts local to the fastener
K_{nom}	nominal (mean) nut factor
m	number of tests
M	applied moment
M_p	fully plastic moment
MS_{sep}	margin of safety for separation
MS_{slip}	margin of safety for slip
MS_u	ultimate margin of safety
MS_y	yield margin of safety
n	load-introduction factor
N	axial force
n_f	number of fasteners in a joint
N_p	fully plastic axial force
p	thread pitch
P'_{sep}	load that causes separation
P'_{tu}	the applied tensile load that causes the fastener load to exceed the fastening system's allowable ultimate tensile load if rupture occurs before separation
P'_{ty}	the applied tensile load that causes the fastener load to exceed the fastening system's allowable yield tensile load, if yielding occurs before separation
P_f	friction load
P_p	preload
P_{pc}	loss of preload from material creep
P_{p-max}	maximum preload
P_{p-min}	minimum preload
P_{pi-j}	initial preload
P_{pi-max}	maximum initial preload
$P_{pi-maxa}$	actual maximum initial preload from a sample of test data
P_{pi-min}	minimum initial preload
$P_{pi-mina}$	actual minimum initial preload from a sample of test data
P_{pi-nom}	nominal (sample mean) initial preload for a given effective torque
P_{pr}	short-term relaxation of preload
P_{sL}	limit shear load
$P_{sL-joint}$	total limit shear load acting on the joint
P_{su}	ultimate design shear load
$P_{su-allow}$	allowable ultimate shear load
P_t	applied tensile load
$P_{t-joint}$	total applied tensile load acting on the joint
$P_{tL-joint}$	total limit tensile load acting on the joint
P_{tb}	tensile load in a preloaded bolt

APPROVED FOR PUBLIC RELEASE – DISTRIBUTION IS UNLIMITED

NASA-STD-5020B

P_{tL}	limit tensile load
P_{tu}	ultimate design tensile load
$P_{tu-allow}$	allowable ultimate tensile load
$P_{ty-allow}$	allowable yield tensile load
$P_{\Delta t-max}$	maximum increase in preload due to temperature
$P_{\Delta t-min}$	maximum decrease in preload due to temperature
Q	applied shear force
Q_p	fully plastic shear force
t	half-thickness of the clamped members (minus any washers)
T_{br-min}	minimum breakaway torque specified for the locking feature
T_{L-max}	maximum locking torque (running torque) specified for the locking feature
T_{max}	maximum effective torque
T_{min}	minimum effective torque
T_{s-max}	maximum specified torque
T_{s-min}	minimum specified torque

3.2.2 Definition of Terms

Allowable Load: The maximum permissible load in a structural part or assembly. As applicable, it can be the specified strength of the hardware (e.g., in a fastener specification); a statistically based, lower-bound, load-carrying capacity derived from test data; or the load derived from the allowable stress of the materials.

Applied Load: Force or moment transferred across a joint; it does not include preload or changes in preload as a result of temperature change. (**Note:** “Applied load” is also referred to in literature as “external load,” “externally applied load,” or “service load.”)

Bolt Grip: For fasteners with a flat bearing surface head, the dimension from the bearing surface under the head to the end of the full diameter body, measured parallel to the axis of the fastener. For fasteners with a conical bearing surface head, the dimension from the top of the head to the end of the full diameter body, measured parallel to the axis of the fastener. Note that these definitions are similar to what some fastener standards use as the definitions for “Grip.”

Catastrophic Hazard: (1) A hazard that could result in a mishap causing fatal injury to personnel, and/or loss of one or more major elements of the flight vehicle or ground facility. (2) A condition that may cause death or permanently disabling injury, major system or facility destruction on the ground, or loss of crew, major systems, or vehicle during the mission

Critical Hazard: A condition that may cause severe injury or occupational illness, or major property damage to facilities, systems, or flight hardware.

Design Separation Load: The limit tensile load multiplied by a separation factor of safety.

APPROVED FOR PUBLIC RELEASE – DISTRIBUTION IS UNLIMITED

NASA-STD-5020B

Detrimental Yielding: Yielding that adversely affects fit, form, function, or integrity of the structure.

Effective Torque: A torque in excess of any running torque.

Factor of Safety: A multiplying factor to be applied to limit loads for purposes of analytical assessment (design factor) or test verification (test factor) of design adequacy in strength or stability.

Failure: Rupture, collapse, excessive deformation, or any other phenomenon resulting in the inability of a structure to sustain specified loads, pressures, and environments or to function as designed.

Fastener: For purposes of this NASA Technical Standard, a bolt or a screw that joins two or more parts and transfers load between them.

Fatigue: The cumulative irreversible damage incurred in materials caused by cyclic application of stresses and environments, resulting in degradation of load-carrying capability.

Fitting Factor: A supplemental factor of safety used in analysis of bolted joints to account for uncertainties in load paths and stresses.

Full Diameter Body: For purposes of this NASA Technical Standard, the ASME B18.12-2001, Glossary of Terms for Mechanical Fasteners definition applies: “The unthreaded portion of a shank whose diameter is generally within the dimensional limits of the major diameter of the thread.” (**Note**: Some fastener specifications refer to the full diameter body as the “full cylindrical portion of the shank” or simply as a “shank.”)

Hardware Developer: Organization directly responsible for the design, manufacture, analysis, test, and safety compliance documentation of the hardware.

Limit Load: The maximum expected applied load, including load transferred across joints as a result of thermally induced loading of the structure; it does not include preload or changes in preload occurring as a result of temperature change.

Locking Feature: A device, chemical substance, or other physical characteristic added by design to one or more elements of a threaded fastening system to resist vibration-induced loosening or to provide retention against complete disengagement of the fastening elements. Preload-induced friction forces between mating joint members, mating threads, or under the head or nut elements of a fastening system inherently resist loosening; however, within this NASA Technical Standard, the term “locking feature” is used to refer only to the added design items described above.

- Prevailing torque feature: Fastening system design that relies on friction to resist fastener rotation independent of preload (i.e., deformed thread or locking patch).

APPROVED FOR PUBLIC RELEASE – DISTRIBUTION IS UNLIMITED

NASA-STD-5020B

- Adhesive locking feature: Fastening system design that uses chemical compounds added at the time of assembly (i.e., anaerobic adhesive, epoxies, urethanes, etc.).
- Mechanical locking feature: Fastening system design employing non-friction elements usually involving a “hard stop” (i.e., cotter pins or safety wire).

Margin of Safety: A measure of a structure’s predicted reserve strength in excess of the design criteria. For a preloaded fastener, it represents the percentage that the design load (limit load multiplied by the applicable factor of safety) can increase before the design criteria are no longer satisfied.

Preload: The tensile force in a bolt and the equivalent compressive force in the joint members when there is no applied load.

Prevailing Torque or Running Torque: The torque required to overcome kinetic friction of the mating threads plus the torque required to overcome the locking feature when 100 percent of the locking feature is engaged and the fastener is unseated. This torque can be measured in either a loosening or a tightening direction while the mating threads are in relative motion.

Separation: The state of no compressive load between mating parts local to the fastener. For a joint designed to maintain a seal, it is further defined as any condition that enables a liquid or gas to penetrate the seal at an unacceptable rate. Also referred to as “gapping.”

Separation-Critical Joint: A joint that fails to function as required if separated.

Separation Load: The minimum applied tensile load that causes separation.

Service Life: All significant loading cycles or events during the period beginning with manufacture of a component and ending with completion of its specified use. Testing, transportation, lift-off, ascent, on-orbit operations, descent, landing, and post-landing events are to be considered.

Service Life Factor (Life Factor): A multiplying factor to be applied to the maximum expected number of load cycles in the service life to determine the design adequacy in fatigue or fracture.

Shank: For purposes of this NASA Technical Standard, the ASME B18.12-2001 definition applies: “That portion of a headed fastener that lies between the head and the extreme point end.”

Threaded Fastening System: (Also referred to as “fastening system.”) An assembled combination of a fastener, an internally threaded part such as a nut or an insert, and also the region of all parts clamped between them, including washers, compressed by the fastener preload.

APPROVED FOR PUBLIC RELEASE – DISTRIBUTION IS UNLIMITED

NASA-STD-5020B

Ultimate Design Load: The product of the ultimate factor of safety, the fitting factor, and the limit load. Also referred to as “design ultimate load.”

Yield Design Load: The product of the yield factor of safety, the fitting factor, and the limit load. Also referred to as “design yield load.”

4. REQUIREMENTS

This section specifies general requirements for threaded fastening systems.

Within each requirement section, there are three sections of text. The actual requirement is shown in normal, non-italicized text along with a requirement label. Rationale for the requirement is shown as italicized text in brackets and is not to be considered a requirement. Additional guidance for each requirement is provided below the rationale statement as italicized text. The guidance is likewise not considered to be a requirement and is not an endorsement of a particular process or equation. The intent of the guidance is to provide additional clarifying language, a demonstration of a principle using a simple condition, or possible techniques or processes to show compliance with the requirement.

4.1 Fastening System Control Plan

[TFSR 1] At the Preliminary Requirements Review, equivalent program milestone review, or project milestone review, each hardware developer shall submit a Fastening System Control Plan to the delegated NASA Technical Authority that:

- a. Shows how the requirements in this NASA Technical Standard are to be satisfied; and
- b. Includes any organization-specific requirements and criteria for design, analysis, fastener installation, and verification; and
- c. Captures or refers to organization-specific processes for ensuring quality and integrity.

[Rationale: A Fastening System Control Plan establishes a defined and approved agreement between the hardware developer and the delegated NASA Technical Authority. By agreeing to the plan early in the design, there is reduced likelihood of disagreements over verification strategies.]

Each hardware developer has the responsibility for submitting a Fastening System Control Plan. The Fastening System Control Plan can be included as a portion of a broader structural verification plan.

APPROVED FOR PUBLIC RELEASE – DISTRIBUTION IS UNLIMITED

NASA-STD-5020B

4.2 Design Factors

4.2.1 Factor of Safety

[TFSR 2] Threaded fastening system hardware shall be designed using the structural factors of safety specified by the program or project for general structural design.

An example is NASA-STD-5001, Structural Design and Test Factors of Safety for Spaceflight Hardware.

[Rationale: Factors of safety are levied to provide margin between predicted service loads and the material strength.]

Factors of safety are applicable to limit load. A yield factor of safety, FS_y , is applied in the assessment of yield strength, and an ultimate factor of safety, FS_u , is applied in the assessment of ultimate strength. Factors of safety do not apply to fastener preload or changes in preload as a result of thermo-elastic deformation local to the fastening system hardware (for example, coefficient of thermal expansion mismatch between the bolt and joint).

4.2.2 Fitting Factor

[TFSR 3] Threaded fastening system hardware shall be designed using a fitting factor (FF).

[Rationale: A fitting factor is included in the strength and separation analysis of each part of the threaded fastening system to account for uncertainties in load paths and stresses.]

The factor of safety is multiplied by the fitting factor and typically applied to the tension and shear components, but not the preload, for fastened joints with multiple bolt locations. An example is shown in Eq. 15.

For purposes of analysis, joint members integral to a larger structural member are considered part of the threaded fastening system up to the point where their section properties become typical of the structural member away from the threaded fastening system.

Ultimate strength analysis of threaded fastening systems should include a fitting factor of at least 1.15 as a multiplier of the required ultimate factor of safety. The selection of a fitting factor for ultimate strength analysis should be strongly influenced by whether there is enough ductility in the critical failure mode to ensure load sharing between fasteners before any one fastening system fails. For example, consider a shear joint with metal joint members: Shear failure of a fastener can have little associated plastic deformation, whereas bearing failure of the joint member typically has considerable plastic deformation. Uneven load sharing can be the result of oversized bolt holes; but even if the bolts are in interference-fit holes, loads may not distribute evenly. If the margin of safety on bearing is lower than the margin of safety for bolt shear (referred to as a bearing-critical joint), shear loads will distribute more evenly between bolts

APPROVED FOR PUBLIC RELEASE – DISTRIBUTION IS UNLIMITED

NASA-STD-5020B

before the highest-loaded bolt fails. A shear-critical joint typically warrants a larger fitting factor.

Yield strength analysis of threaded fastening systems whose performance is particularly sensitive to local yielding should include a fitting factor of at least 1.15 as a multiplier of the required yield factor of safety.

In threaded fastening systems where there is clearance between the fasteners and the bearing surfaces, there is a likelihood that some fasteners may not share the load equally; and some fasteners may be unloaded. The selection of the fitting factor or the prediction of load sharing should reflect the expected clearances between the fasteners and the bearing surfaces and the stiffness of the fastened joint members.

The value of the fitting factor may be reduced when there is less uncertainty in the load paths and stresses or there is little sensitivity to those uncertainties in the analysis of threaded fastening systems. A fitting factor of 1.0 may be adequate in the strength analysis of fastened joints when at least one of the following applies:

- The threaded fastening system's strength is verified in an ultimate load test in which actual load paths and stresses are simulated in the joint and surrounding structure; or*
- The threaded fastening system's load paths and stresses have been determined with detailed finite element analysis using modeling practices that have been correlated with tests of similar threaded fastening systems in which actual load paths and stresses were simulated and measured; or*
- The threaded fastening system contains redundant load paths (e.g., multiple fasteners) and sufficient ductility to allow the load to redistribute before failure.*

Separation analysis of joints that are separation-critical should include a fitting factor of at least 1.15 as a multiplier of the required separation factor of safety.

A fitting factor of 1.0 may be adequate in the strength analysis of fastened joints when at least one of the following applies:

- The threaded fastening system is not separation-critical; or*
- The threaded fastening system is separation-critical but the joint's functionality is verified in a test to limit load or greater on hardware representative of the flight design in which actual load paths and stresses are simulated in the joint and surrounding structure; or*
- The threaded fastening system is separation-critical but the joint's load paths and stresses have been determined with detailed finite element analysis using modeling*

APPROVED FOR PUBLIC RELEASE – DISTRIBUTION IS UNLIMITED

NASA-STD-5020B

practices that have been correlated with tests of similar threaded fastening systems in which actual load paths and stresses were simulated and measured.

4.2.3 Separation Factor of Safety

[TFSR 4] Threaded fastening system hardware shall be designed using the separation factor of safety (FS_{sep}) specified by Figure 1, Logic Flow for Minimum Separation Factor of Safety.

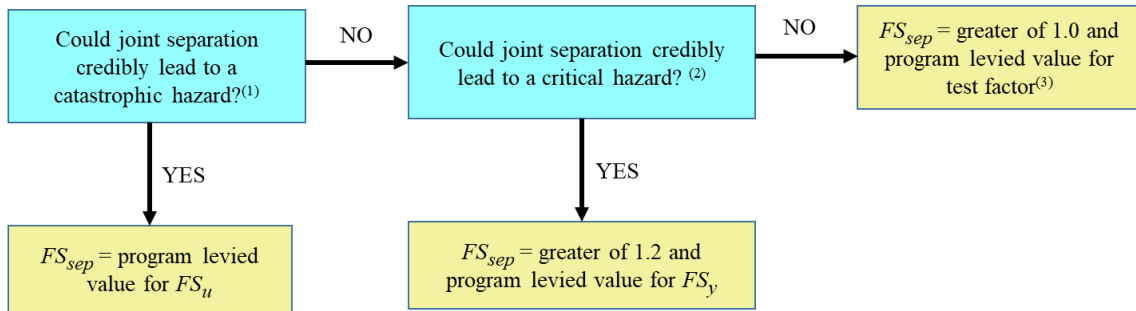

⁽¹⁾A hazard that could result in a mishap causing fatal injury to personnel, and/or loss of one or more major elements of the flight vehicle or ground facility. A condition that may cause death or permanently disabling injury, major system or facility destruction on the ground, or loss of crew, major systems, or vehicle during the mission.

⁽²⁾A condition that may cause severe injury or occupational illness, or major property damage to facilities, systems, or flight hardware.

⁽³⁾If testing, such as proof or acceptance, is to be performed at higher than limit load, the factor should be increased to envelope test conditions to preclude separation during test.

Figure 1—Logic Flow for Minimum Separation Factor of Safety

[Rationale: A factor of safety greater than 1.0 applied to separation analysis provides additional margin between predicted service loads and the nominal or minimum expected preload in a fastened joint.]

A separation-critical joint is a joint that fails to function as required if separated. Examples of separation-critical joints include, but are not limited to, joints that must maintain contact to enable proper function of a system (e.g., thermal, electrical, fluid) or joints whose dynamic stiffness is reduced due to separation.

Primary structure with joints classified as “non-separation critical” and $FS_{sep} = 1.0$ could separate when tested above limit load (e.g., qualification tests using 1.25 x limit load) producing alignment/performance issues, a shift in dynamic response, or both. In these scenarios, if the consequence of joint separation during testing can lead to a failure to satisfy test success criteria, then consider selecting a greater value for FS_{sep} to produce a positive margin of safety on separation under test loads and environments, as well as flight loads and environments.

4.3 Fastening System Preload

Common methods of achieving a desired preload during installation are controlling the installation torque, controlling the turn angle of a nut or bolt head after the fastening system is seated, measuring the fastener’s change in length, and using strain gauges on the fastener body.

APPROVED FOR PUBLIC RELEASE – DISTRIBUTION IS UNLIMITED

NASA-STD-5020B

These methods are listed in order of increasing labor, cost, and accuracy. The most economical method, torque control, is the least accurate for controlling preload.

Refer to Appendix A for explanation and justification of fastener analysis criteria.

4.3.1 Maximum and Minimum Preload

[TFSR 5] Maximum and minimum preload calculations shall account for the preload variation associated with the method of developing initial preload, potential relaxation, creep, and the effects of maximum and minimum expected temperatures.

[Rationale: Many variables can affect the preload that is developed in a threaded fastening system during and after assembly. Proper characterization and use of the full range of possible preloads are necessary to ensure structural integrity is verified.]

Maximum and minimum preloads are calculated as

$$P_{p-max} = P_{pi-max} + P_{\Delta t-max} \quad (\text{Eq. 1})$$

$$P_{p-min} = P_{pi-min} - P_{pr} - P_{pc} - P_{\Delta t-min} \quad (\text{Eq. 2})$$

where P_{pi-max} and P_{pi-min} are the maximum and minimum initial preloads, respectively; the other variables are defined in Table 1, Analytical Adjustments of Maximum and Minimum Preloads.

NASA-STD-5020B

Table 1—Analytical Adjustments of Maximum and Minimum Preloads

<i>Symbol</i>	<i>Description</i>	<i>Adjustment used when calculating maximum preload</i>	<i>Adjustment used when calculating minimum preload</i>
P_{pr}	<i>Short-term relaxation of preload (often attributed to embedment of imperfectly matched surfaces); see Appendix A.3</i>	<i>Zero</i>	<i>5% of minimum initial preload for joints with all-metallic clamped parts, test-derived value for joints with any non-metallic parts or coatings)⁽¹⁾</i>
P_{pc}	<i>Loss of preload from material creep</i>	<i>Zero</i>	<i>Calculated maximum expected preload loss from creep, if applicable</i>
$P_{\Delta t-max}$ $P_{\Delta t-min}$	<i>Change of preload with temperature (differential coefficients of thermal expansion and temperature dependence of elastic moduli)⁽²⁾</i>	<i>Calculated maximum increase in preload, $P_{\Delta t-max}$, for maximum or minimum expected temperatures</i>	<i>Calculated maximum decrease (as a positive number) in preload, $P_{\Delta t-min}$, for maximum or minimum expected temperatures</i>
<i>⁽¹⁾For fastened joints with multiple faying surfaces, the assumption of 5 percent relaxation may be non-conservative. In these cases, it is recommended to perform testing to determine the relaxation or analysis that considers the creep-relaxation behavior of the fastening system design.</i>			
<i>⁽²⁾An effective technique to minimize the change of preload with temperature is described in the SAE AIR 1754A, Washer, Thermal Compensating, Metric Series.</i>			

Maximum initial preload for strength and fatigue analyses is calculated as

$$P_{pi-max} = c_{max}(1 + \Gamma)P_{pi-nom} \quad (\text{Eq. 3})$$

where P_{pi-nom} is the nominal (mean) preload applicable to installation, Γ is the preload variation, and c_{max} is a factor that accounts for the maximum value of the controlled installation parameter, as allowed by the specified tolerance. For example, if torque control is used and the effective torque is specified as 40 ± 2 N-m, then $c_{max} = (40 + 2)/40 = 1.05$.

For use in separation analysis of separation-critical joints and for fatigue analysis, minimum initial preload is calculated as

$$P_{pi-min} = c_{min}(1 - \Gamma)P_{pi-nom} \quad (\text{Eq. 4})$$

APPROVED FOR PUBLIC RELEASE – DISTRIBUTION IS UNLIMITED

NASA-STD-5020B

where c_{\min} is a factor that accounts for the minimum value of the controlled installation parameter, as allowed by the specified tolerance. For example, if torque control is used and the effective torque is specified as 40 ± 2 N-m, then $c_{\min} = (40 - 2)/40 = 0.95$.

For use in joint-slip analysis and separation analysis of joints that are not separation-critical, minimum initial preload is calculated as

$$P_{pi-\min} = c_{\min} \left(1 - \frac{\Gamma}{\sqrt{n_f}} \right) P_{pi-\text{nom}} \quad (\text{Eq. 5})$$

where n_f is the number of fasteners in the joint. See Appendix A.2 for rationale.

In addition to the adjustments noted in Table 1, loss of preload may occur if the joint experiences cyclic slip. To minimize any such loss, the joint should be designed in any one of the following ways:

- Not to slip; or
- With minimal clearance fits achieved by specifying precision fasteners having a closely controlled or “close tolerance” full diameter body in conjunction with precision holes per National Aerospace Standard (NAS) 618, Fastener – Recommended Shank, Hole, and Head-to-shank Fillet Radius, Limits For; or
- With liquid thread fillers that cure properly; or
- With shear pins (dowel pins) or other dedicated shear-transfer devices.

4.3.2 Nominal Preload

[TFSR 6] Calculation of the nominal (mean) initial preload, $P_{pi-\text{nom}}$, shall be substantiated by tests of a minimum of six sets of the fastening system hardware per Table 2, Nominal Preload Determination, to determine the relationship between initial preload and the parameter controlled during installation (torque, turn-of-nut, turn-angle, or bolt stretch).

[Rationale: When using torque control, the torque-preload relationship has been shown to be sensitive to where lubrication is applied. Significant differences have been observed, for example, when lubricating only under the head compared to under the head and nut. When using turn-of-nut, turn-angle, or bolt stretch designs, the torque-preload relationship has been observed to be configuration dependent; therefore, tests should use hardware and processes that are identical to the flight design.]

NASA-STD-5020B

Table 2—Nominal Preload Determination

	Torque Control ^(1,2)	Turn-of-Nut or Turn-Angle	Bolt Stretch
The fastening system hardware has the same diameter and thread form, the same type and number of washers, same materials, and same nut/nut plate/insert as the flight assembly. The clamped part and washer that are adjacent to a non-rotating bolt head or non-rotating nut are not critical and are allowed to vary from the flight assembly.	R	R	R
Cleaning, lubricants, and lubrication process are the same as flight assembly.	R	R	NR
The fastening system hardware is the same specification (part number) as the flight assembly hardware.	NR	R	R
Installation process is the same as flight assembly.	NR	R	R
<p>R=Required, NR=Desirable but not required</p> <p>⁽¹⁾ At least three tests (install, torque, and removal) should be performed on each of the six sets of fastening system hardware for a total of eighteen tests, unless reuse is prohibited in the flight assembly.</p> <p>⁽²⁾ See NASM 1312-15, Fastener Test Methods, Method 15, Torque-Tension, for guidance for torque-tension testing.</p>			

4.3.3 Preload Variation

[TFSR 7] The preload variation, F , used to calculate the minimum and maximum initial preload shall be based on the criteria of Table 3, Preload Variation Determination.

[Rationale: Testing has demonstrated that when the same torque is applied, there is variability in the measured preload. To ensure safe operation of fastening system hardware, this variability should be accounted for in the design. A 90 percent probability and 95 percent confidence limit was selected to provide balance, analogous to a B-basis quantity, between conservatisms and limiting the required test matrix to a reasonable number of specimens.]

APPROVED FOR PUBLIC RELEASE – DISTRIBUTION IS UNLIMITED

NASA-STD-5020B

Table 3 – Preload Variation Determination

Method	Separation Critical	Non-Separation Critical
Torque Control	Envelope of statistical basis ⁽¹⁾ and variation to satisfy Table 2 ⁽²⁾ while using a. Lot-specific testing (testing the procurement lot of fastening system hardware that will be used for spaceflight) ⁽³⁾ or b. Testing equal numbers of sets of fastening system hardware of the same specification as the flight-assembly hardware, from each of at least three procurement lots ⁽³⁾	a. Statistical basis ⁽¹⁾ , or b. Greater of (1) 25 percent (if lubricated), (2) 35 percent (if non-lubricated or as-received), (3) Variation from tests to satisfy Table 2 ⁽²⁾
Turn-of-Nut or Turn Angle	Envelope of statistical basis ⁽¹⁾ and variation to satisfy Table 2 ⁽²⁾	a. Statistical basis ⁽¹⁾ , or b. Greater of (1) 25 percent (2) Variation from tests to satisfy Table 2 ⁽²⁾
Bolt Stretch	Envelope of statistical basis ⁽¹⁾ and variation to satisfy Table 2 ⁽²⁾	a. Statistical basis ⁽¹⁾ , or b. Greater of (1) 10 percent (2) Variation from tests to satisfy Table 2 ⁽²⁾

⁽¹⁾90 percent probability and 95 percent confidence (two-sided distribution), with tests meeting the configuration requirements of Table 2.

⁽²⁾The variation from the tests to satisfy Table 2 is given by the minimum and maximum values of preload relative to the nominal preload such that $\Gamma_{a-max} = P_{pi-max} / P_{pi-nom} - 1$ and $\Gamma_{a-min} = 1 - P_{pi-min} / P_{pi-nom}$.

⁽³⁾Each fastener to be installed, torqued, and removed at least three times unless reuse is prohibited for the flight assembly. When reuse is prohibited, only the data from the first cycle is used.

For non-separation critical joints, Table 3 provides several methods for determining the preload variation, Γ . The preferred approach is to use a statistical basis with 90 percent probability and

NASA-STD-5020B

95 percent confidence for a two-sided distribution. However, to avoid excessive testing, it is permissible to use the alternate (not the statistical) method shown in Table 3.

When using the alternate (not the statistical) method for non-separation critical joints, if the test-measured variation exceeds the Γ values stated above, then the test-measured variation should be used or methods for reducing the preload variation should be pursued.

When using the alternate method for torque control, a fastener is considered to be lubricated if a solid-film, grease, or liquid lubricant is applied to the threads and to the turning bearing surfaces of the nut or the bolt head (or to the washer under the nut or the bolt head).

Appendix A.2 shows an example of how to calculate minimum and maximum preloads when preload is generated with torque control.

4.4 Strength Requirements

4.4.1 Ultimate Design Loads

[TFSR 8] Threaded fastening system hardware shall withstand ultimate design loads (limit load times the ultimate factor of safety and fitting factor) without failure when subjected to:

- a. The accompanying service environments (for example, temperature) and
- b. A coefficient of friction between clamped parts equal to zero (applicable only to verification by analysis, not applicable to verification by test) (see TFSR 13).

Withstanding ultimate design loads can be demonstrated by test or by analysis where a non-negative margin of safety is calculated.

Use of friction to react applied shear forces between the clamped parts is not permissible for ultimate load assessment.

[Rationale: Withstanding the ultimate design loads validates the integrity of the structure against failure in the expected service environment. Under ultimate load conditions, it is assumed that static friction is overcome and shear forces are reacted through bearing contact.]

Failure, as used in TFSR 8, is the inability to meet any performance requirements applicable at ultimate load. Examples of failure include rupture of the joint and leaking of a joint that can credibly lead to a catastrophic hazard.

Assessment for ultimate design loads addresses potential rupture in all elements of the threaded fastening system, including the fastener, the internally threaded part such as a nut or an insert, and the clamped parts. Assessment of a procured item such as a nut or a threaded insert should be based on the strength specified for that item rather than on thread-stripping analysis. Such items can expand under load, reducing the thread engagement areas.

APPROVED FOR PUBLIC RELEASE – DISTRIBUTION IS UNLIMITED

NASA-STD-5020B

Each internally threaded part used for design should have either a specified and controlled allowable tensile load, or an allowable tensile load derived from dedicated testing. Many threaded inserts have two allowable tensile loads that should be considered: the minimum allowed tensile load capability of the insert internal threads, and the minimum allowed tensile load for pullout of the insert from the parent material. One or both may be provided in the insert specification (or the procurement specification). The lower value should be used for strength analysis.

When performing ultimate analysis, the analysis should account for load redistribution due to geometric design features, localized yielding, separation, or slipping. The loads acting on individual members of the fastened joint are dependent on features of the joint design (e.g., fastener to bearing surface clearance), materials (e.g., a bearing-critical versus shear-critical joint design), and friction (resistance to slipping is highest under a preloaded member and drops with distance from the member). Examples of load redistribution are shown in Appendix A.12.

An insert's allowable pull-out load depends on the material in which the insert is installed (parent material). The most common failure mode associated with pull-out is shear of internal threads in the parent material. The specifications (or procurement specifications) for most threaded inserts define how the allowable pull-out load is calculated such as by multiplying a specified minimum shear engagement area by the allowable ultimate shear stress of the parent material. Such an allowable pull-out load applies when the insert is installed in a solid, homogenous material. For inserts installed in nonhomogeneous or nonmetallic materials or in sandwich panels, allowable pull-out loads should be derived from test. Nuts should be limited to the load rating of the nut.

The margin of safety indicates how much the applied load can increase before the criteria are no longer satisfied. Simplistic equations for calculating the margin of safety for ultimate under axial load are

$$MS_u = \frac{P_{tu-allow}}{FF \cdot FS_u \cdot P_{tL}} - 1 \quad (\text{Eq. 6})$$

when separation occurs before rupture, and

$$MS_u = \frac{P'_{tu}}{FF \cdot FS_u \cdot P_{tL}} - 1 \quad (\text{Eq. 7})$$

when rupture occurs before separation, where P'_{tu} is the applied tensile load that causes the fastener load to exceed the fastening system's allowable ultimate tensile load if rupture occurs before separation, and $P_{tu-allow}$ is the allowable ultimate load for the fastening system.

Linear theory, empirical, or semi-empirical methods can be used to assess ultimate tensile strength of the fastening system and if rupture occurs before separation. Appendix A.6 provides further detail on this approach. With linear theory, the tensile load in a preloaded bolt, P_{tb} ,

APPROVED FOR PUBLIC RELEASE – DISTRIBUTION IS UNLIMITED

NASA-STD-5020B

increases proportionally with the applied tensile load per Eq. 8 until either any part in the fastening system ruptures or separation occurs.

$$P_{tb} = P_p + n\phi P_t \quad (\text{Eq. 8})$$

where P_p is the preload, P_t is the applied tensile load, n is the load-introduction factor (see Appendix A.4) that depends on the joint design and accounts for where the load is applied to the joint, and ϕ is the stiffness factor. The stiffness factor is

$$\phi = \frac{k_b}{k_b + k_c} \quad (\text{Eq. 9})$$

where k_b is the stiffness of the bolt and k_c is the stiffness of the clamped parts local to the fastener.

Based on Eq. 8 and the assumption of maximum preload, P_{p-max} , the applied tensile load that causes the bolt load to exceed the allowable ultimate tensile load for the fastening system, P'_{tu} , is

$$P'_{tu} = \frac{1}{n\phi} (P_{tu-allow} - P_{p-max}) \quad (\text{Eq. 10})$$

and the linearly projected load that causes separation when at maximum preload is

$$P'_{sep} = \frac{P_{p-max}}{1 - n\phi} \quad (\text{Eq. 11})$$

If P'_{sep} is less than P'_{tu} , linear theory predicts that separation would occur before rupture, and the ultimate margin of safety for tensile loading is calculated per Eq. 6. Conversely, Eq. 7 should be used when P'_{sep} is greater than P'_{tu} , as linear theory predicts rupture would occur before separation.

The allowable ultimate shear load for a fastener depends on whether or not the threads are in the shear plane. If threads are not in the shear plane, the allowable ultimate shear load per shear plane is commonly assumed to be half the value given in the fastener specification for double-shear joints, when applicable, or is calculated by

$$P_{su-allow} = \frac{\pi D^2 F_{su}}{4} \quad (\text{Eq. 12})$$

where F_{su} is the allowable ultimate shear strength for the fastener material. If threads are in the shear plane, the allowable ultimate shear load for a fastener is calculated by

$$P_{su-allow} = F_{su} A_m \quad (\text{Eq. 13})$$

APPROVED FOR PUBLIC RELEASE – DISTRIBUTION IS UNLIMITED

NASA-STD-5020B

where A_m is the minimum minor-diameter area for the fastener threads. The ultimate margin of safety for shear loading of a fastener is

$$MS_u = \frac{P_{su-allow}}{FF \cdot FS_u \cdot P_{SL}} - 1 \quad (\text{Eq. 14})$$

where P_{SL} is the limit shear load acting on the shear plane.

4.4.2 Yield Design Loads

[TFSR 9] Threaded fastening system hardware shall withstand yield design loads (limit load times the yield factor of safety and fitting factor) without detrimental yielding or detrimental deformation when subjected to the accompanying service environments (for example, temperature).

[Rationale: Withstanding yield design loads validates the integrity of the structure against yielding or deformations that could adversely affect the functionality of critical systems in the expected service environment.]

Withstanding yield design loads can be demonstrated by test or by analysis where a non-negative margin of safety is calculated.

Yield strength analysis is not required if there is no detrimental yielding or detrimental deformations at the yield design load. The assessment for yield design loads will address all elements of the threaded fastening system, including the fastener, the internally threaded part such as a nut or an insert, and the clamped parts.

Examples of detrimental deformations include

- *Fastener yielding causing the joint to separate under an applied tensile load that is less than the design separation load.*
- *Fastener yielding causing the joint to suffer detrimental slip under an applied shear load that is less than the applicable design shear load.*
- *Deformations that degrade mission performance.*
- *Some other design-specific reason exists for why fastener yielding is detrimental (e.g., any fastener yielding that adversely affects the form, fit, or function of the design).*

In a typical joint with preload generated by torque control, fastener yielding under combination of preload and applied load is not detrimental for separation (see first bullet above), given the separation analysis criteria specified in section 4.4.3. Rationale and exceptions for the above statement, as well as a discussion of the effects of fastener yielding on joint slip (see second bullet above), are provided in Appendix A.9.

APPROVED FOR PUBLIC RELEASE – DISTRIBUTION IS UNLIMITED

NASA-STD-5020B

When performing yield analysis, the analysis should account for load redistribution due to geometric design features, localized yielding, separation, or slipping. The loads acting on individual members of the fastened joint are dependent on features of the joint design (e.g., fastener to bearing surface clearance), materials (e.g., a bearing-critical versus shear-critical joint design), and friction (resistance to slipping is highest under a preloaded member and drops with distance from the member). Examples of load redistribution are shown in Appendix A.12.

In a linear analysis, the margin of safety indicates how much the applied load can increase before the minimum design factor of safety criterion is no longer satisfied. In some instances, it may be difficult to demonstrate a positive margin of safety under yield design loads. Care must be taken when calculating the margin of safety to avoid being overly conservative in the analysis. For example, due to the geometry of fastener threads, even under nominal initial preload, a portion of material at thread roots could be above yield. It is not intended that highly localized peak stresses that may be predicted by computer-aided methods of analysis and may be blunted by confined yielding must demonstrate a positive margin of safety.

Simplistic equations for calculating the margin of safety for yield under axial load are

$$MS_y = \frac{P_{ty\text{-allow}}}{FF \cdot FS_y \cdot P_{tL}} - 1 \quad (\text{Eq. 15})$$

when separation occurs before yield, and

$$MS_y = \frac{P'_{ty}}{FF \cdot FS_y \cdot P_{tL}} - 1 \quad (\text{Eq. 16})$$

when yield occurs before separation, where

$$P'_{ty} = \frac{1}{n\phi} (P_{ty\text{-allow}} - P_{p\text{-max}}) \quad (\text{Eq. 17})$$

where P'_{ty} is the applied tensile load that causes the fastener load to exceed the fastening system's allowable yield tensile load if yielding occurs before separation, P_{tL} is the limit tensile load, $P_{ty\text{-allow}}$ is the allowable tensile load of the material, n is the load-introduction factor that depends on the joint design and accounts for where the load is applied in the joint, and ϕ is the stiffness factor. See Appendix A.4 for an explanation of the load-introduction and stiffness factors. The quantity $P_{p\text{-max}}$ is the maximum initial preload (see section 4.3.1). The allowable yield tensile load can be estimated using the equation below when a value is not explicitly defined in the corresponding fastener specification or relevant test data is unavailable, as

$$P_{ty\text{-allow}} = \left(\frac{F_{ty}}{F_{tu}} \right) P_{tu\text{-allow}} \quad (\text{Eq. 18})$$

NASA-STD-5020B

where $P_{tu\text{-allow}}$ is the allowable ultimate load of the fastener in tension, and F_{ty} and F_{tu} are the yield and ultimate strength of the fastener material, respectively. $P_{tu\text{-allow}}$ will have considerations for the fastener geometric features and will typically be the capability of the threaded section of the fastener. Eq. 15 and Eq. 16 are not applicable to all load conditions and are provided as examples only.

Because shear yield strength is not a standard material property, when evaluating the margin of safety under yield design loads and performing combined loads analysis, the normal and shear components of stress should be transformed into principal stresses; and a failure theory (e.g., von Mises or Tresca) should be used that is compatible with the concept of tensile yield strength.

4.4.3 Separation Loads

[TFSR 10] Threaded fastening system hardware shall withstand design separation loads (limit load times the separation factor of safety and fitting factor) without loss of compression between the joint members or detrimental deformation due to separation when subjected to the accompanying service environments (for example, temperature).

[Rationale: Withstanding the separation design loads validates the integrity of the structure against the detrimental effects of separation in the expected service environment.]

Withstanding design separation loads can be demonstrated by test or by analysis where a non-negative margin of safety is calculated.

Separation is not strictly prohibited in all applications. Separation may be permissible when:

- *Separation does not cause detrimental deformations; and*
- *Separation does not cause a critical or catastrophic hazard; and*
- *Strength requirements in sections 4.4.1 and 4.4.2 are met in the separated condition; and*
- *The life requirement in section 4.5 is met when accounting for the separated condition.*

Examples of detrimental separation deformations include:

- *Reduction in compression of a seal or gasket that enables a liquid or gas to leak at an unacceptable rate; or*
- *Separation that interrupts a critical electrical path; or*
- *Separation that degrades the thermal contact conductance between mated parts; or*
- *Separation that causes a change in stiffness or load path credibly leading to a load condition that causes detrimental yield or collapse of the structure; or*

APPROVED FOR PUBLIC RELEASE – DISTRIBUTION IS UNLIMITED

NASA-STD-5020B

- Separation that reduces the fatigue life of the fastener due to an increase in the amplitude of the cyclic load.

Separation analysis should account for load redistribution due to joint geometry, localized yielding, partial or full separation, or slipping. The loads acting on individual joint members are dependent on features of the joint design (e.g., fastener to bearing surface clearance), materials (e.g., a bearing-critical versus shear-critical joint design), and friction (resistance to slipping is highest under a preloaded member and drops with distance from the member). Examples of load redistribution are shown in Appendix A.12.

See Appendix A.11 for additional information on using minimum preload to calculate the margin of safety under separation loads. A simplistic equation to evaluate the margin of safety for separation, MS_{sep} , is

$$MS_{sep} = \frac{P_{p-min}}{FF \cdot FS_{sep} \cdot P_{tL}} - 1 \quad (\text{Eq. 19})$$

where FS_{sep} is the separation factor of safety per section 4.2.3. The equation is applicable to systems under axial loading only. Other equations or methods may be used to evaluate the margin of safety when combined loading is considered.

When a joint maintains a seal (e.g., to maintain pressure or contain a fluid), the analysis may be complex, particularly if the joint has a seal or gasket. In such cases, Eq. 19 does not accurately predict the margin of safety for separation; and the analysis approach depends on the design of the joint and the seal.

It is advisable to assume that minimum preload exists for all the fasteners in the joint to maximize robustness of the joint.

4.4.4 Combination of Loads

[TFSR 11] The limit, yield, ultimate, and separation loads shall account for interaction of the combined loading (simultaneously applied tensile, shear, and bending loads) and under all design environmental conditions.

[Rationale: Depending on the configuration of the fastened joint members and the applied mechanical loading, the members could experience a combination of forces and moments. Neglecting the combined effects of forces and moments that are physically reacted by joint members is non-conservative.]

Interaction equations for the ultimate condition are shown in this section. These interaction equations may be used, but other interaction equations based on test data or test-substantiated analysis methods may be substituted.

NASA-STD-5020B

When assessing the strength of the fastener due to combined loading, if shear is not transferred across gaps or non-load carrying spacers, or if interference or close tolerance fits are used, then typically there is no need to account for bolt bending caused by the shear loading. However, if the shear is transferred across gaps or non-load carrying spacers, or if there are clearances between the bolt and joint, interaction of loads, including non-negligible bending, should be considered.

For fasteners under simultaneously applied tensile and shear loads, along with any applicable bending, analysis should account for interaction of the combined loading. Preload may be omitted in the interaction check at the ultimate condition.

For the case in which the full-diameter body is in the shear plane rather than the threads, satisfying either of the criteria given by Eq. 20 and Eq. 21 is acceptable for the ultimate condition. The criterion given by Eq. 20 should be satisfied when not accounting for plastic bending, or the criterion given by Eq. 21 should be satisfied when accounting for plastic bending.

$$\left(\frac{P_{su}}{P_{su-allow}}\right)^{2.5} + \left(\frac{P_{tu}}{P_{tu-allow}} + \frac{f_{bu}}{F_{tu}}\right)^{1.5} \leq 1 \quad (\text{Eq. 20})$$

$$\left(\frac{P_{su}}{P_{su-allow}}\right)^{2.5} + \left(\frac{P_{tu}}{P_{tu-allow}}\right)^{1.5} + \left(\frac{f_{bu}}{F_{bu}}\right) \leq 1 \quad (\text{Eq. 21})$$

where $P_{su-allow}$ is calculated using Eq. 12, P_{su} is the ultimate design shear load per shear plane, f_{bu} is the design ultimate bending stress based on linear-elastic theory, F_{tu} is the allowable ultimate tensile stress, and F_{bu} is the allowable ultimate flexural stress (bending, that applies for ductile materials as a result of plastic bending. Use of F_{bu} , which depends on the material and the cross section, accounts for the additional moment-carrying capacity of a section in bending over and above the capacity calculated based on linear-elastic theory.

Inclusion of the bending stress term in the criteria given in Eqs. 20 and 21 is considered to be conservative. These criteria, with omission of the bending stress term, are based on tests of A-286 3/8-24 (NAS1956C14) fasteners performed at NASA MSFC in 2010, as documented in NASA/TM-2012-217454, Aerospace Threaded Fastener Strength in Combined Shear and Tension Loading.

For the case in which the threads are in the shear plane, as is typically the case for a bolt going into a tapped hole or a threaded insert, satisfying either of the criteria given by Eqs. 22 and 23 is acceptable. The criterion given by Eq. 22 should be satisfied when not accounting for plastic bending, or the criterion given by Eq. 23 should be satisfied when accounting for plastic bending.

$$\left(\frac{P_{su}}{P_{su-allow}}\right)^{1.2} + \left(\frac{P_{tu}}{P_{tu-allow}} + \frac{f_{bu}}{F_{tu}}\right)^2 \leq 1 \quad (\text{Eq. 22})$$

APPROVED FOR PUBLIC RELEASE – DISTRIBUTION IS UNLIMITED

NASA-STD-5020B

$$\left(\frac{P_{su}}{P_{su-allow}}\right)^{1.2} + \left(\frac{P_{tu}}{P_{tu-allow}}\right)^2 + \left(\frac{f_{bu}}{F_{bu}}\right) \leq 1 \quad (\text{Eq. 23})$$

where $P_{su-allow}$ is calculated using Eq. 13. The shear capability of a fastener is greatest when the full diameter body is in the shear plane and is reduced when the threads are in the shear plane due to cross-sectional area reduction.

Note the difference in exponents used in Eqs. 22 and 23 (threads in shear plane) as compared with those used in Eqs. 20 and 21 (full diameter body in shear plane). Tensile and shear stresses peak at the same cross section when the threads are in the shear plane; when the full diameter body is in the shear plane, the tensile and shear stresses do not peak at the same cross section. Inclusion of the bending stress term in the criteria given in Eqs. 22 and 23 is considered to be conservative.

4.4.5 Inclusion of Preload in Yield and Ultimate Load Strength

[TFSR 12] If rupture occurs before separation, preload shall be included in the determination of the total tensile load in the preloaded bolt.

[Rationale: When joint members separate prior to rupture, the tensile load in the bolt is equal to the applied mechanical load; whereas if rupture occurs prior to separation, there is a contribution to failure from preload.]

When a fastened joint is completely separated prior to rupture, the total axial component of the load acting on the bolt is equal to the axial component of the applied load only. If rupture occurs before separation, preload also acts on the bolt and should be included when assessing the performance of the fastened joint. In this case, a factor of safety is not applied to preload. Whether separation would occur before rupture can be determined based on test or analysis. Refer to Appendix A.5 and A.6 for guidance.

4.4.6 Use of Friction at Limit and Yield Load

a. [TFSR 13] Use of friction to react shear loads shall only be permissible for analysis at limit load (alignment, fatigue, and fracture) or yield load.

Beneficial effects of friction are not permissible in analysis for ultimate load conditions.

[Rationale: When a bolt begins to yield under the combination of preload and applied load, preload relaxes and the shear force reacted by friction at the faying surfaces decreases. It is not conservative to assume that friction carries any of the shear load when assessing ultimate strength.]

APPROVED FOR PUBLIC RELEASE – DISTRIBUTION IS UNLIMITED

NASA-STD-5020B

b. [TF SR 14] Unless otherwise substantiated by test, the coefficient of friction for joint-slip analysis shall be no greater than:

- (1) 0.20 for uncoated, non-lubricated metal surfaces that are cleaned by a qualified process and visibly clean at and after assembly.
- (2) 0.10 for all other surfaces, including nonmetallic (coated or uncoated) surfaces and metallic surfaces that are coated with any substance, including lubricant, paint, and conversion coating.

[Rationale: The coefficient of friction is highly dependent on the materials in contact, environmental conditions, contact force distribution, and presence of coatings, lubricants, or contamination. Test data indicates that dry and wet conditions across a variety of designs can have a minimum value as reported above.]

When friction is used as a load path for shear loading, the analysis should show no slippage at the applicable design load (see Appendix A.10 for guidance on joint-slip analysis). If the margin of safety for joint slip is negative, then friction cannot be used in analysis as a load path for shear loading.

Note that positive margins of safety are required for ultimate design loads without reliance on friction to ensure high structural reliability regarding catastrophic failure.

When selecting the value of the coefficient of friction, values lower than those presented above should be used if the design warrants it. The requirement sets the maximum value allowed without test data. For example, in some designs such as with Teflon™-coated surfaces, the coefficient of friction may be less than 0.10. A value consistent with such a design should be used instead of the value of 0.10.

Higher values may be used with program- or project-approved testing in a relevant environment. When values are substantiated by test, the tests should mimic the environmental conditions expected in the service environment and using materials, coatings, and cleanliness consistent with the hardware design.

Friction may be included as a shear-load path for the following types of analysis for joints using preloaded fasteners:

- *Yield-strength analysis of the joint members (e.g., bearing).*
- *Analysis for ensuring a structural assembly maintains required alignment of mechanical interfaces.*
- *Fatigue or fracture mechanics analysis.*

Relying on friction to carry shear across a joint is a departure from past NASA policy. This departure is intentional for the purpose of encouraging good design practice. In structural

APPROVED FOR PUBLIC RELEASE – DISTRIBUTION IS UNLIMITED

NASA-STD-5020B

assemblies subject to cyclic loads or vibration such as aerospace structures, joints using threaded fasteners in oversized holes are most dependable if shear is transferred by friction, by close-fit or interference-fit shear pins (dowel pins), or by other dedicated shear-transfer features rather than by the fasteners themselves. This is especially true for fasteners going into tapped holes or threaded inserts, with threads in the shear plane. When shear pins (dowel pins) are not practical, the fasteners should be highly preloaded; and care should be taken to clean the faying surfaces and prevent contamination from oils or other lubricants to maximize the coefficient of friction.

If the joint members slip within the limits of the fasteners' clearance holes:

- A nonlinearity is introduced within the assembly that can compromise the accuracy of dynamic loads analysis and predicted load distribution.*
- A damaging shock can be introduced when the fasteners contact the sides of the clearance holes.*
- The first fasteners within a pattern to contact the sides of the clearance holes are potentially overloaded.*
- The structural assembly may suffer detrimental misalignment.*
- If the slip is cyclic, the fasteners may lose preload despite the presence of locking features.*
- If the slip is cyclic and the fastener threads are in the shear plane, as is typically the case for fasteners threading into tapped holes or threaded inserts, the fastener may fail in fatigue.*

If friction is inadequate for preventing slip at limit load and no shear pin (dowel pin) is present, the severity of the above effects should be reduced by ensuring minimal clearance fits, achieved by specifying precision fasteners having a closely controlled or "close tolerance" full diameter body in conjunction with precision holes per NAS 618. Fasteners installed into tapped holes or threaded inserts typically require relatively large-clearance fits between fasteners and their holes to account for location tolerances. As such, shear pins (dowel pins) should be used unless friction is adequate for preventing slip at limit load.

4.5 Fatigue Life

[TFSR 15] All threaded fastening systems shall be designed to withstand the entire service life, including the life scatter factor specified by the program or project, and service environment without fatigue failure.

APPROVED FOR PUBLIC RELEASE – DISTRIBUTION IS UNLIMITED

NASA-STD-5020B

[Rationale: Static rupture is not the only structural failure mechanism for threaded fastening systems. In some instances, due to design or service loads, failure due to fatigue has been observed.]

Fatigue life requirements for threaded fastening systems are the same as those in the general structural requirements levied by NASA on the hardware developer (e.g., NASA-STD-5001). Typically, verification of service life may be by either of the following methods:

- *Fatigue analysis using the fatigue analysis factor and service life factor specified in the applicable structural requirements (e.g., NASA-STD-5001), or*
- *Fatigue testing using the service life factor specified in the applicable structural requirements (e.g., NASA-STD-5001).*

Alternatively, with the prior approval of the delegated NASA Technical Authority, similarity to the hypothetical fastened joint described below and in Appendix C may be used to verify a fatigue failure is unlikely to occur in lieu of fatigue analysis or testing. This approach does not relieve any fracture control requirements.

Fasteners used in hardware that is under fracture control are verified for fatigue life if they are designated as fracture critical and the required crack growth (damage tolerance) analysis is performed (e.g., NASA-STD-5019, Fracture Control Requirements for Spaceflight Hardware). Note that fracture control requirements may not be levied by NASA for some projects, particularly projects for uncrewed spaceflight hardware. Fasteners under fracture control that are designated as non-fracture critical (e.g., fail-safe) typically can satisfy fracture control without a crack growth analysis. However, the fatigue life requirement of this NASA Technical Standard must still be verified to substantiate adequate design of the fastening parts for the expected service life and environments.

4.6 Locking Features

It should be recognized that some locking features are not a means of maintaining preload but rather are safety devices principally intended to resist rotational loosening and prevent loss of fasteners. Examples of the selection of locking features are provided in Appendix B.

4.6.1 Preload Independent Locking Feature

[TFSR 16] Regardless of the magnitude of preload, each threaded fastening system in spaceflight hardware shall incorporate a minimum of one locking feature that does not depend upon preload to function.

[Rationale: Previous spaceflight missions have been affected by fastening system hardware that loosened and became liberated, causing loss of joint integrity or foreign object debris that compromised completion of mission objectives.]

APPROVED FOR PUBLIC RELEASE – DISTRIBUTION IS UNLIMITED

NASA-STD-5020B

Devices such as jam nuts may not be suitable locking features to satisfy this requirement if they require preload to function effectively or if a change in preload could compromise the locking performance. A redundant locking feature may be advisable for some joints as described in Federal Aviation Administration (FAA) Advisory Circular (AC) 20-71, Dual Locking Devices on Fasteners, December 8, 1970.

An estimate for the self-loosening moment can be calculated as the product of the preload times the thread pitch divided by 2π . For reference, consult "Threaded Fastener Secondary Locking Requirements" (D. P. Hess, Journal of Failure Analysis and Prevention, Vol. 17, Number 4).

4.6.2 Mechanical Locking Feature

[TFSR 17] A mechanical locking feature shall be used on any bolt subject to rotation in operation.

[Rationale: Bolts subject to rotation during operation (not including installation or removal of the bolt) may produce forces that would overcome the effectiveness of a prevailing torque or adhesive locking feature. A pure mechanical feature such as safety wire has been demonstrated to be effective at preventing liberation of fastened joint members.]

A bolt is considered to be subject to rotation if it serves as an axis of rotation producing relative motion between the bolt and one or more components attached to the bolt. Friction-type locking features include prevailing torque and adhesive locking features that rely on friction to resist loosening or provide retention. On a bolt subject to rotation in operation, the relative motion between parts may produce forces capable of overcoming the locking friction, so friction-type locking features are not suitable except when they are used in conjunction with a mechanical locking feature such as a cotter pin or safety wire. For reference, consult FAA AC 20-71 and FAA AC 23.607-1, Self-Locking Nuts on Bolts Subject to Rotation, August 24, 1984. If safety wire is used, it is advised to prevent the failure of the safety wire and allow permissible bolt rotation by wiring the nut and bolt to each other exclusively. In this situation, do not safety wire the bolt and the nut to an adjoining structural member. For guidance on safety wire design, see (SAE) International AS567K, Safety Cable, Safety Wire, Key Washers, and Cotter Pins for Propulsion Systems, General Practices for Use of.

4.6.3 Liquid Locking Compound Process Control

[TFSR 18] When using locking adhesives, whether as thread-locking compounds or staking materials, installation processes shall be developed and validated prior to implementation to ensure adhesives cure, adhere, and function as expected.

[Rationale: Lack of proven process controls has been shown to compromise the performance of liquid locking compounds. If process controls are not developed that enable the full functionality of the compounds, the expected locking characteristics can be compromised.]

APPROVED FOR PUBLIC RELEASE – DISTRIBUTION IS UNLIMITED

NASA-STD-5020B

Requirements for staking of nonstructural fastening systems used on electrical printed wiring assemblies (PWA) are found in NASA-STD-8739.1, Workmanship Standard for Polymeric Application on Electronic Assemblies.

4.6.4 Locking Feature Verification

[TFSR 19] The presence and performance (locking moment) of locking features shall be verified using the methods of Table 4, Locking Feature Torque Verification.

[Rationale: Locking features reduce the likelihood of fastening system components becoming foreign object debris that could affect flight or system performance. Mechanical locking features such as safety wire and safety cable are preferred in external environments where liberation of elements could create critical or catastrophic hazards.]

Table 4—Locking Feature Torque Verification

Locking Feature Type	Method
Mechanical <i>(including, but not limited to, cotter pins, safety wire, and safety cable)</i>	Visual inspection after installation
Prevailing Torque <i>(including, but not limited to, deformed thread features and non-metallic pellets, strips, or patches)</i>	Torque measurement during installation ⁽¹⁾
Liquid Locking Compounds <i>(including, but not limited to, adhesives, sealants, thread lockers, and chemical thread pre-coats that are applied to the threads and cured prior to joint assembly)</i>	Torque measurement on witness specimens using the same materials and processes, and processed at the same time, as the hardware being verified ⁽²⁾
<p>⁽¹⁾Verification of prevailing torque locking features by torque measurement may be omitted with prior approval of the delegated NASA Technical Authority if loss of fastener does not credibly cause a catastrophic hazard and if other controls are utilized to minimize the likelihood of assembly with inadequate locking features. Examples of such controls are fastener lot acceptance testing of locking feature performance, locking feature surveillance with periodic measurement of prevailing torque on like fasteners in flight hardware assemblies, technician training to recognize when no prevailing torque is present, etc. The rationale for this approach needs to properly consider fastener reuse if fastener reuse is permitted in the flight assembly. Preloaded joint analyses cannot assume a specified torque ‘above running torque’ if prevailing torque is not measured. Relaxation of this verification requirement is generally intended for secondary or tertiary structures such as P-clamps.</p> <p>⁽²⁾For adhesive locking features that are not sensitive to the threaded fastening system materials or configuration, cure samples processed at the time of application/processing may be used for verification.</p>	

NASA-STD-5020B

Compounds that are pre-applied and dried without curing before installation and with no bonding between mating threads are not considered adhesives and should not be used in applications that could credibly result in severe injury, loss of life, or loss of vehicle.

Proper installation processes are located in specifications such as National Aerospace Standard NASM 33540, Safety Wiring, Safety Cabling, Cotter Pinning, General Practices for, and SAE AS567K.

Example verification methods for each of the locking feature types listed above are located in various sections of Appendix B.

4.7 Part Selection Criteria

Requirements in this section may already be covered as part of a broader set of design requirements levied on the program. It is highly recommended that the requirements in this section be reviewed for duplication against existing program requirements. In cases where there is duplication, it is recommended to apply tailoring to this NASA Technical Standard and not apply some or all of the requirements of this section.

4.7.1 Materials

[TFSR 20] Materials used in threaded fastening systems shall comply with NASA-STD-6016, Standard Materials and Processes Requirements for Spacecraft.

[Rationale: Material issues of particular importance for threaded fastening systems include galling, corrosion, stress-corrosion cracking, hydrogen embrittlement, creep, outgassing, and effects of atomic oxygen. These issues and others are addressed in NASA-STD-6016.]

4.7.2 Thread Form Compatibility

[TFSR 21] Mating threaded parts shall have compatible thread forms.

[Rationale: Using incompatible thread forms can result in dimensional interference and may lead to seizure, inadequate strength, inadequate preload for a specified torque value, or inability to disassemble.]

Examples of incompatible thread combinations are:

- *Fine threads mated to coarse threads, or*
- *Inch-based threads mated to metric threads, or*
- *Mated threads with the same pitch and different nominal diameters, or*
- *External UNJ threads mated to UN internal threads, or*
- *External MJ threads mated to M internal threads.*

APPROVED FOR PUBLIC RELEASE – DISTRIBUTION IS UNLIMITED

4.7.3 Use of Washers and Chamfered Bolt Holes

[TFSR 22] Clearance shall be provided for the head-to-shank fillet radius as needed to avoid interference with the clamped parts through the use of chamfered holes or countersunk washers installed under bolt heads with the countersink facing the bolt head (see Figure 2, Dimensional Considerations in Selecting Fastening Hardware.)

[Rationale: Interferences between mating components can lead to unreliable preload, reduced strength, or inadequate performance against separation of a nominally designed fastening system.]

Flush-head screws should be installed without washers under the head.

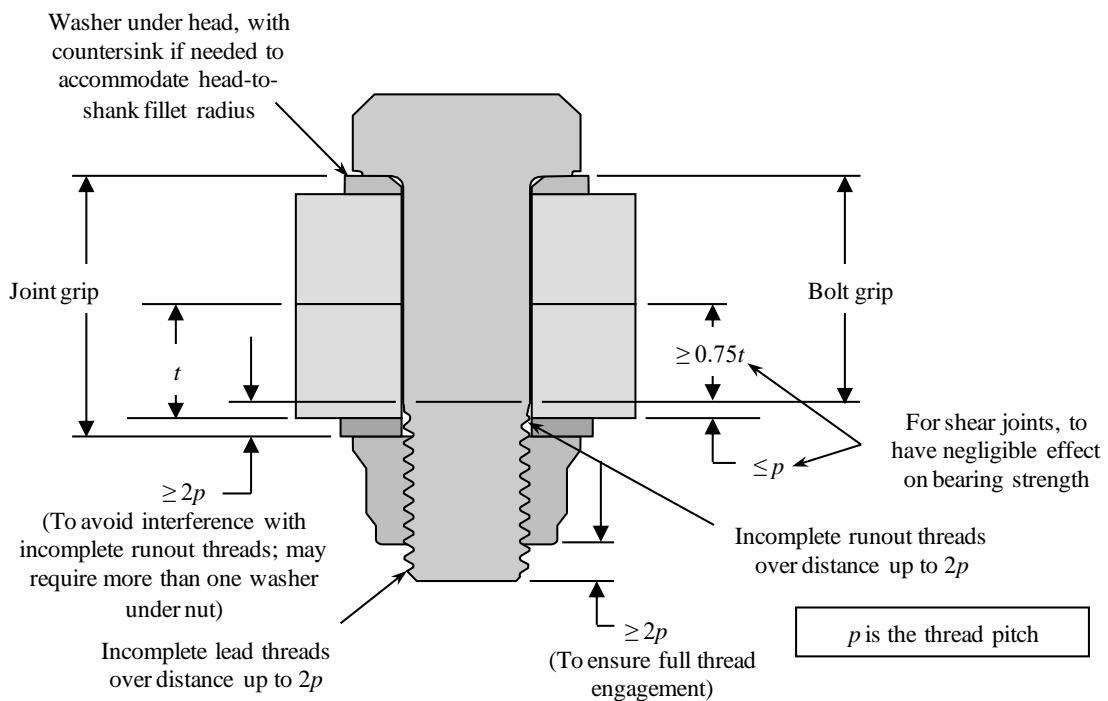

Figure 2—Dimensional Considerations in Selecting Fastening Hardware

4.7.4 Fastener Length Selection for Thread Engagement

[TFSR 23] When the threaded fastening system incorporates a prevailing torque locking feature, the fastener length shall be sufficient for fully formed threads to engage the locking feature.

[Rationale: The location of the locking feature is not consistent across all designs; so when a prevailing torque locking feature is used as a control to satisfy the requirement for a preload independent locking feature, the fastener length should be sufficient to fully engage the feature.]

To ensure that all internal threads are fully engaged, the length of each fastener used with a nut, nut plate, or insert should be selected to extend a distance of at least twice the thread pitch, p ,

NASA-STD-5020B

past the outboard end of the nut, nut plate, or insert. Figure 2 points out common methods of addressing dimensional issues in hardware selection for a fastener used with a nut.

To avoid thread stripping as the critical failure mode, thread engagement in an internally threaded part other than a nut, nut plate, or insert should be selected to ensure the minimum number of engaged complete threads such that the fastener would fail in tension before threads would strip. It is desirable to have the fastener fail in tension before the threads strip to facilitate ease of repair and to increase the likelihood that any failed hardware may be detected. In addition, fastener tensile failures typically exhibit more plastic deformation prior to rupture, allowing loads to redistribute between fasteners before failure occurs in any one threaded fastening system.

4.7.5 Bolt Grip Selection to Prevent Interference

a. [TFSR 24] For a fastener with a full diameter body, the bolt grip and the number and type of washers shall be selected to ensure the internal threads do not encroach on the incomplete runout threads of the fastener.

[Rationale: Inadequate bolt grip can lead to engaging the incomplete runout threads, thereby introducing uncertainty in the preload.]

Where complete threads transition to the unthreaded full diameter body, incomplete runout threads exist over a distance up to twice the pitch on most commercial aerospace fasteners.

If the nut or the insert engages the incomplete runout threads, interference may occur and the intended preload may not be achieved.

b. [TFSR 25] Fasteners threaded into blind holes shall be selected to prevent contacting the bottom of the hole or interfering with incomplete internal threads.

[Rationale: Improper bolt grip selection that leads to interferences can lead to unpredictable performance of as-installed fasteners.]

Where blind holes are tapped, incomplete internal threads are present at the bottom of the hole.

4.8 Quality Assurance

Requirements in this section may already be covered as part of a broader overall quality assurance program levied on the program. It is highly recommended that the requirements in this section be reviewed for duplication against existing program requirements. In cases where there is duplication, it is recommended to apply tailoring to this NASA Technical Standard and not apply some or all of the requirements of this section.

4.8.1 Design Documentation

[TFSR 26] The engineering documentation shall specify:

APPROVED FOR PUBLIC RELEASE – DISTRIBUTION IS UNLIMITED

NASA-STD-5020B

- a. The part or identifying numbers of fastening system hardware, and
- b. Required lubricants, coatings, or sealants used in threaded fastening systems, the area to which they are applied, as well as their application processes, and
- c. Dimensions and tolerances necessary to manufacture and assemble the fastened joint and its constituent parts, and
- d. The types, locations, and allowable quantities of washers, and
- e. The installation methods and parameters for achieving preload, and
- f. The installation torque range or applicable standard that defines the installation torque range, and
- g. Whether the specified torque is total torque or the torque above running torque.

[Rationale: Engineering documentation such as drawings, analysis, and process specifications are important to verify that the design, analysis, and assembly are consistent.]

Lubrication of fasteners prior to assembly is often desirable and sometimes necessary to prevent galling or to reduce preload variation when using torque control. For a given applied torque, use of lubricants, coatings, or sealants can increase the preload and reduce variation in preload compared to an unlubricated joint. The surfaces on which lubricants, coatings, or sealants are applied, or the surfaces to which they migrate, influence preload as well. Lubricants also reduce wear, inhibit fretting, and improve ease of installation and removal of fasteners.

Lubricants used in sensitive applications such as fluid wetted components, optical systems, and some external spacecraft surfaces can result in system contamination and performance degradation. Application of lubricant in excess of the amount necessary to achieve the design performance should be avoided, even in non-sensitive applications.

When engineering documentation does not specify “above running torque,” the specified torque is understood to be the final torque indicated by the torque instrument. Running torque does not generate preload. Specifying torque above a measured running torque provides tighter control of preload.

The engineering documentation should specify whether torque is to be applied to the fastener head or the nut because the relationship between torque and preload is different depending upon which part is torqued. Whenever possible, torque should be applied to the nut. When torque is applied to the fastener head, the fastening system should be designed to ensure no binding occurs between any parts of the rotating shank and its clearance hole.

APPROVED FOR PUBLIC RELEASE – DISTRIBUTION IS UNLIMITED

NASA-STD-5020B

When it is important for joints with multiple fasteners to have an evenly distributed clamp load, an appropriate torque sequence along with incremental torquing should be specified on the engineering drawing or hardware-specific installation procedure. Example procedures for multi-fastener preloading can be found in MIL-HDBK-60, Threaded Fasteners-Tightening to Proper Tension, Section 5.7: Flange Joint Bolt Tensioning.

4.8.2 As-Built Documentation

[TFSR 27] Records documenting the as-built procedures and configuration of each assembly shall be created and maintained by the hardware developer and provided for review upon request by the delegated NASA Technical Authority.

[Rationale: As-built records show evidence that the hardware was assembled using parts and procedures in conformance with the approved design and that as-built variances are noted. As-built records are necessary for physical configuration audits.]

4.8.3 Training

[TFSR 28] Personnel installing fastening system hardware shall be trained per program-, project-, or organization-specific quality process.

[Rationale: Training ensures that technicians have the proper knowledge and skills for effectively performing the tasks associated with installing threaded fastening systems on spaceflight hardware. Fastener installation with insufficiently trained personnel can result in as-built non-conformances resulting in critical and catastrophic hazards.]

4.8.4 Tools and Instruments

a. [TFSR 29] Tools and instruments used to install fastening system hardware shall be verified to be in calibration prior to use and used within their design and calibration ranges.

[Rationale: Improperly calibrated tools lead to uncertainty in the amount of initial preload in the system.]

If, during use of a tool or instrument there is a condition where the calibration may be invalidated such as dropping, impact, or other damage, it should be confirmed that the calibration is still valid.

b. [TFSR 30] Torque instruments shall conform to ASME B107.300-2010, Torque Instruments, or a NASA-approved alternative.

[Rationale: This NASA Technical Standard provides performance and safety requirements for manually operated torque instruments.]

APPROVED FOR PUBLIC RELEASE – DISTRIBUTION IS UNLIMITED

NASA-STD-5020B

Torque instruments should be chosen so the torque (running or final assembly) being measured or controlled is between 20 and 90 percent of the instruments' full-scale torque.

4.8.5 Threaded Fastening System Hardware Inspection

[TFSR 31] Threaded fastening system hardware shall be inspected prior to installation to verify that part number(s), cleanliness, and orientation are in accordance with the engineering documentation.

[Rationale: Improperly installed fastening system hardware can lead to functional or structural integrity issues not considered in the design of the system hardware.]

4.8.6 Fastening System Hardware Procurement, Inspection, and Storage

[TFSR 32] Procurement, receiving inspection, and storage of threaded fastening system hardware that joins or retains components or structural elements shall meet the requirements of NASA-STD-8739.14, NASA Fastener Procurement, Receiving Inspection, and Storage Practices for NASA Mission Hardware.

Examples of fastening system hardware that are subject to this requirement include, but are not limited to, bolts, screws, nuts, nut plates or anchor nuts, rivets, shear pins, helical or cylindrical inserts, setscrews, washers, safety wire, and cotter pins.

Adherence to NASA-STD-8739.14 is mandatory for threaded fastening system hardware whose failure or disengagement could result in a critical hazard, catastrophic hazard, or generate foreign object debris that can credibly and negatively affect the functional performance of unrelated systems. For all other fastening system hardware, adherence to NASA-STD-8739.14 is recommended but not mandatory.

[Rationale: This NASA Technical Standard establishes requirements, responsibilities, and practices to ensure that threaded fastening system hardware meets quality assurance requirements deemed necessary by NASA for safe and reliable performance.]

APPENDIX A

EXPLANATION AND JUSTIFICATION OF FASTENER ANALYSIS CRITERIA

A.1 Purpose of Appendix A

This Appendix provides an explanation and justification of fastener analysis criteria.

A.2 Accounting for Preload Variation when Installing Fasteners with Torque Control (Supplement to Section 4.3.1)

This section is intended to clarify the criteria in section 4.3.1 and to provide additional guidance regarding calculation of maximum and minimum preloads when using torque control.

The relationship between preload and torque can be characterized by a statistical distribution. Multiple tests have shown that this distribution is usually normal (Gaussian), and the mean and standard deviation can be inferred from the test data with varying degrees of confidence. Thus, for a given input torque, there is a normal probability distribution for the resulting preload having a mean and a standard deviation.

The relationship between the nominal (mean) initial preload, P_{pi-nom} , and the nominal effective torque, T , can be expressed as

$$P_{pi-nom} = \frac{T}{K_{nom}D} \tag{Eq. 24}$$

where $1/K_{nom}$ is the nominal (mean) of the inverse of the nut factor ($1/K$) and D is the nominal bolt diameter.

Maximum initial preload is calculated by modifying Eq. 3 as

$$P_{pi-max} = \frac{(1 + \Gamma)T_{max}}{K_{nom}D} \tag{Eq. 25}$$

where Γ is the preload variation, and T_{max} is the maximum effective torque. For use in separation analysis of separation-critical joints, minimum initial preload is calculated by modifying Eq. 4 as

$$P_{pi-min} = \frac{(1 - \Gamma)T_{min}}{K_{nom}D} \tag{Eq. 26a}$$

NASA-STD-5020B

where T_{min} is the minimum effective torque. For use in separation analysis of joints that are not separation-critical and joint-slip analysis, minimum initial preload is calculated by modifying Eq. 5 as

$$P_{pi-min} = \left(1 - \frac{\Gamma}{\sqrt{n_f}}\right) \frac{T_{min}}{K_{nom}D} \quad (\text{Eq. 26b})$$

The maximum and minimum effective torques are calculated as follows:

- If the installation torque is specified as some value or range “above running torque,” or if a locking feature that does not introduce a running torque is used,

$$T_{max} = T_{s-max} \quad (\text{Eq. 27})$$

$$T_{min} = T_{s-min} \quad (\text{Eq. 28})$$

where T_{s-max} and T_{s-min} are the maximum and minimum specified torques, respectively. For example, if the torque specification is “60 ± 3 in-lb above running torque,” $T_{max} = T_{s-max} = 63$ in-lb and $T_{min} = T_{s-min} = 57$ in-lb.

- Otherwise, the maximum and minimum effective torques are calculated by subtracting the extreme values of running torque from the specified torques:

$$T_{max} = T_{s-max} - T_{br-min} \quad (\text{Eq. 29})$$

$$T_{min} = T_{s-min} - T_{L-max} \quad (\text{Eq. 30})$$

where T_{br-min} is the minimum breakaway torque specified for the locking feature (can be conservatively set equal to zero) and T_{L-max} is the maximum locking torque (running torque) specified for the locking feature.

Section 4.3.2 herein requires that calculation of the nominal initial preload, P_{pi-nom} , be substantiated by test. Because the torque-preload relationship is not truly linear, as Eq. 24 suggests, the most accurate method of determining P_{pi-nom} for a given effective torque, T , is to compute the sample mean (average) preload measured at that effective torque during the tests:

$$P_{pi-nom} = \frac{1}{m} \sum_{j=1}^m P_{pi-j} \quad (\text{Eq. 31})$$

where j is the test number, P_{pi-j} is the initial preload obtained in the j -th test, and m is the number of tests. The nominal nut factor is then calculated by rearranging Eq. 24:

NASA-STD-5020B

$$K_{nom} = \frac{T}{DP_{pi-nom}} \quad (\text{Eq. 32})$$

Section 4.3.3 herein requires that, when using torque control and without applicable data showing otherwise, the preload variation, Γ , for use in Eq. 25 and 26a and b (in all analyses except separation analysis of separation-critical joints) should be 25 percent for fasteners lubricated at assembly and 35 percent for non-lubricated and as-received fasteners. Historic NASA criteria have specified that when using torque control of preload, lubricated bolts have a preload uncertainty (variation), Γ , of ± 25 percent from a typical (nominal or mean) value, and non-lubricated bolts have a preload uncertainty of ± 35 percent from a typical value. It historically has been assumed that these preload uncertainties envelop some large, but undefined, percentage of the probability distribution. Section 4.3.3 goes on to say, “When using the alternate (not the statistical) method for non-separation critical joints, if the test-measured variation exceeds the Γ values stated above, then the test-measured variation should be used or methods for reducing the preload variation should be pursued.” The “actual extreme variation” referred to here is calculated from test data as two values, Γ_{a-max} and Γ_{a-min} :

$$\Gamma_{a-max} = \frac{P_{pi-maxa}}{P_{pi-nom}} = 1 \quad (\text{Eq. 33})$$

or

$$\Gamma_{a-min} = 1 - \frac{P_{pi-mina}}{P_{pi-nom}} \quad (\text{Eq. 34})$$

where $P_{pi-maxa}$ and $P_{pi-mina}$ are the actual maximum and minimum initial preloads measured in the torque-preload tests. Eq. 33 applies to the establishment of Γ when calculating maximum preload, and Eq. 34 applies when calculating minimum preload. When calculating maximum preload, Γ is then the greater of Γ_{a-max} and the default value (0.25 lubricated, 0.35 non-lubricated). When calculating minimum preload, Γ is then the greater of Γ_{a-min} and the default value (0.25 lubricated, 0.35 non-lubricated).

Per section 4.3.3, calculation of minimum initial preload for separation analysis of separation-critical joints requires Γ to be derived from test data as the value determined to be at a statistical basis of 90 percent probability and 95 percent confidence (two-sided distribution). This value, $\Gamma_{90/95}$, may also be used per section 4.3.3 to calculate maximum preload or to calculate minimum preload for joints that are not separation-critical. To determine the $\Gamma_{90/95}$ value, first calculate the unbiased sample standard deviation, σ_{pi} , from the collected sample of initial preloads for a given torque:

$$\sigma_{pi} = \sqrt{\frac{1}{m-1} \sum_{j=1}^m (P_{pi-j} - P_{pi-nom})^2} \quad (\text{Eq. 35})$$

APPROVED FOR PUBLIC RELEASE – DISTRIBUTION IS UNLIMITED

NASA-STD-5020B

The preload variation at 90 percent probability and 95 percent confidence is then

$$\Gamma_{90/95} = \frac{s\sigma_{pi}}{P_{pi-nom}} \quad (\text{Eq. 36})$$

where s is the number of standard deviations from the mean applicable to 90 percent probability and 95 percent confidence; s varies with sample size, m , as given in Table 5, Two-Sided 90/95 Tolerance Limit Factors for a Normal Distribution (Odeh and Owen, 1980).

**Table 5—Two-Sided 90/95 Tolerance Limit Factors for a Normal Distribution
(Odeh and Owen, 1980)**

m	s	m	s	m	s	m	s
2	31.092	12	2.670	22	2.272	40	2.055
3	8.306	13	2.601	23	2.251	45	2.024
4	5.368	14	2.542	24	2.232	50	1.999
5	4.291	15	2.492	25	2.215	55	1.978
6	3.733	16	2.449	26	2.199	60	1.960
7	3.390	17	2.410	27	2.184	65	1.944
8	3.156	18	2.376	28	2.170	70	1.931
9	2.986	19	2.346	29	2.157	80	1.908
10	2.856	20	2.319	30	2.145	90	1.890
11	2.754	21	2.294	35	2.094	100	1.875

As an example, consider a torque-preload test of 10 sets of fastening system hardware, with each cycled 3 times in the as-received condition. The effective torque, T , is 450 in-lb, and the nominal bolt diameter, D , is 0.375 in. The measured preloads are listed in Table 6, Sample Data from 30 Torque-Tension Tests (Actual Test Data).

Table 6—Sample Data from 30 Torque-Tension Tests (Actual Test Data)

	Bolt 1	Bolt 2	Bolt 3	Bolt 4	Bolt 5	Bolt 6	Bolt 7	Bolt 8	Bolt 9	Bolt 10
Test 1	7760	4010	3587	4635	4920	3797	4462	4940	6220	4780
Test 2	7229	4310	3900	4322	4475	3812	4132	4219	6100	4685
Test 3	6080	4291	3054	4804	3910	3303	4090	4550	6062	5180

From Eqs. 31 through 36, with $n = 30$ and $s = 2.145$,

$$P_{pi-nom} = 4,721 \text{ lb}$$

$$K_{nom} = \frac{450}{0.375(4721)} = 0.254$$

APPROVED FOR PUBLIC RELEASE – DISTRIBUTION IS UNLIMITED

NASA-STD-5020B

$$\Gamma_{a-max} = \frac{7760}{4721} - 1 = 0.644$$

$$\Gamma_{a-min} = 1 - \frac{3054}{4721} = 0.353$$

To calculate P_{pi-max} , $\Gamma = 0.644$ (higher of Γ_{a-max} and 0.35).

Alternatively, it is acceptable to use $\Gamma = \Gamma_{90/95}$, calculated as follows:

$$\sigma_{pi} = \sqrt{\frac{1}{m-1} \sum_{j=1}^m (P_{pi-j} - P_{pi-nom})^2} = 1,097 \text{ lb}$$

$$\Gamma_{90/95} = \frac{2.145(1097)}{4721} = 0.498$$

To calculate P_{pi-min} , if the joint is not separation-critical, $\Gamma = 0.353$ (higher of Γ_{a-min} and 0.35), that is less penalizing than the alternative of using $\Gamma = \Gamma_{90/95} = 0.498$.

Note that, in the above example, there is unusually high variation in the initial preloads obtained for the given torque. In such a case, it is advisable to investigate the cause of such high variation in Γ and take appropriate steps such as modifying the installation process by use of lubrication or selecting different fastening system hardware.

A.2.1 Rationale for Eqs. 5 and 26b

When performing slip analysis, the concern related to preload is not the variation in preload for a single fastener, it is the variation in total preload for the joint. Because the preload for any single bolt in the joint has a probability distribution for a given torque, then the total preload for the bolt pattern has a probability distribution. The total preload equals the mean preload for the bolts in the pattern multiplied by the number of fasteners, so the probability distribution for total preload is the same as the probability distribution for the mean preload for the bolts in the pattern. This distribution is referred to as the *distribution of the means*, and it is characterized using the *Central Limit Theorem* as having a mean equal to the mean of the population (the mean of the distribution for any single bolt) and a standard deviation equal to the standard deviation of the population divided by the square root of the number of bolts in the bolt pattern. So, for a joint containing a number of bolts, n_f , the probability distribution for the total preload for the n-bolt pattern has a mean, $\mu_{nbp} = \mu_p$, and a standard deviation, $\sigma_{nbp} = \sigma/\sqrt{n_f}$. It can be assumed that the distribution of the means is normal.

The *Central Limit Theorem* states that the distribution of the means approaches a normal distribution as the size of the sample used to calculate the mean approaches infinity, even if the distribution of the population is non-normal. For practical purposes, the distribution of the

APPROVED FOR PUBLIC RELEASE – DISTRIBUTION IS UNLIMITED

NASA-STD-5020B

means is near normal when the sample size is greater than or equal to 30 (Spiegel, 1961, p. 144). The distribution of the means “tends to be normally distributed even for relatively small n [sample size] as long as no single element or small group of elements has a dominating variance and the element distributions do not deviate extremely from a normal distribution” (Hahn and Shapiro, 1967, p. 73). The standard deviation of the distribution of the means is also known as the “standard error.”

When performing separation analysis, part of the concern is separation of the entire joint; and part of the concern is local separation near a single fastener. The minimum preload used for separation analysis of separation-critical joints must be derived by test at the statistical probability and confidence specified in section 4.3.1. For joints that are not separation-critical, it is acknowledged that the consequence of local separation in a joint with multiple fasteners is not as severe as the consequence of rupture or detrimental yielding; so it is acceptable to base the separation analysis on a minimum preload that is progressively less conservative as the number of fasteners in the pattern increases. Although the *Central Limit Theorem* does not apply to preload at a single fastener (it applies only to total preload for a bolt pattern and thus separation analysis for the overall joint), it is acceptable for separation analysis at the highest-loaded fastener in a non-separation-critical joint to use a minimum preload calculated the same way in which it is calculated for slip analysis, as noted above and specified in section 4.3.1.

Separation under cyclic applied load, whether for the entire joint or local to a fastener, is undesirable as it causes more fatigue damage in the fastener. Fatigue analysis, however, must account for the full range in preload with uncertainty as specified in section 4.3.1. When assessing non-separation-critical joints with multiple fasteners, if the pattern has a positive margin of safety for separation at the joint level but the highest-loaded fastener in the pattern has a negative margin of safety for separation at the local level, fatigue analysis must account for the increase in tension due to separation.

A.3 Short-Term Relaxation of Preload (Supplement to Section 4.3.1)

Table 1 provides an adjustment for short-term relaxation of preload. Such relaxation is a well-documented effect attributed to embedment that results from localized yielding at interfaces. When calculating minimum preload, it is acceptable in most cases to reduce the minimum initial preload by 5 percent for short-term relaxation. Higher losses of preload have been reported as a result of short-term relaxation due to stack up of washers, smaller-diameter washers, low-yield strength materials, etc. In such cases, even for all-metal threaded fastening systems, larger reductions may be necessary.

A.4 Use of a Load-Introduction and Stiffness Factor (Supplement to Sections 4.4.1 and 4.4.2)

The load-introduction factor (LIF), n , as used in Eq. 17 and Eq. 8, accounts for the effects on the tensile bolt load due to the joint geometry and location of the external load. The LIF can be derived based on a linear spring model as shown in “The Mechanism of Bolt Loading” (H. M. Lee, NASA TM-108337), or by including off-center tensile loads and flange bending effects as

APPROVED FOR PUBLIC RELEASE – DISTRIBUTION IS UNLIMITED

NASA-STD-5020B

shown in “Effect of Separating Load Eccentricity on the Clamp Load Loss in a Bolted Joint Using a Strain Hardening Model” (Nassar & Ganganala, ASME Journal of Pressure Vessel Technology, April 2011, Vol. 133). Verein Deutscher Ingenieure (VDI) 2230, Systematic Calculation of High Duty Bolted Joints, Joints with One Cylindrical Bolt, provides the LIF for various joint geometry characteristics based on analysis and experiment. The LIF, n , may be determined using the aforementioned references, and varies between 0 and 1 depending on the joint geometry and the point of application of the external load.

Historically, in National Space Transportation System (NSTS) 08307, Criteria for Preloaded Bolts, the LIF has been defined solely as a length ratio of the thickness of the relieved joint materials between loading-plane locations L_{lp} , to the total thickness of the joint L , as

$$n = \frac{L_{lp}}{L} \quad (\text{Eq. 37})$$

where L and L_{lp} are as defined in Figure 3, Dimensions Used to Calculate the Geometric Load-Introduction Factor, for three types of joints. Because this definition of the LIF is characterized solely by intuitive geometric considerations, it is hereafter denoted as the geometric LIF.

The value for the LIF can be calculated using various methods such the methods of NSTS 08307, NASA TM-108337, or VDI 2230. The method found in NASA TM-108337 is denoted herein as the stiffness-based LIF, further explained below, and is considered more accurate than other handbook solutions since it accounts for more realistic stiffness considerations of the bolted joint. A method that provides even more accuracy, assuming the bolted joint design is properly represented, is finite element analysis.

The stiffness-based LIF usually allocates less external load to the bolt than does the geometric LIF. Therefore, if the stiffness-based LIF is used, care must be taken to make sure that accurate external loads (by considering load amplifying affects such as prying action and material nonlinearities, etc.) are used so that non-conservative margins of safety are avoided.

This idealization of the preloaded bolted joint assumes that the tensile component of the external load acts collinearly with the bolt axis (and ignores the effect of dimension b , as shown in Figure 3). This idealization also assumes that this load and its reaction acts as uniform pressures on loading-planes perpendicular to the bolt axis, separated by a distance equal to the thickness of the relieved joint material, L_{lp} , and being bounded by the joint compression zone boundaries. It can be shown analytically that this LIF is based on the implicit assumption that the compression zone is of constant area and of uniform modulus of elasticity. Both of these implicit assumptions are generally not true, in that the compression zone usually has some type of varying geometry, and clamped members also commonly consist of different materials.

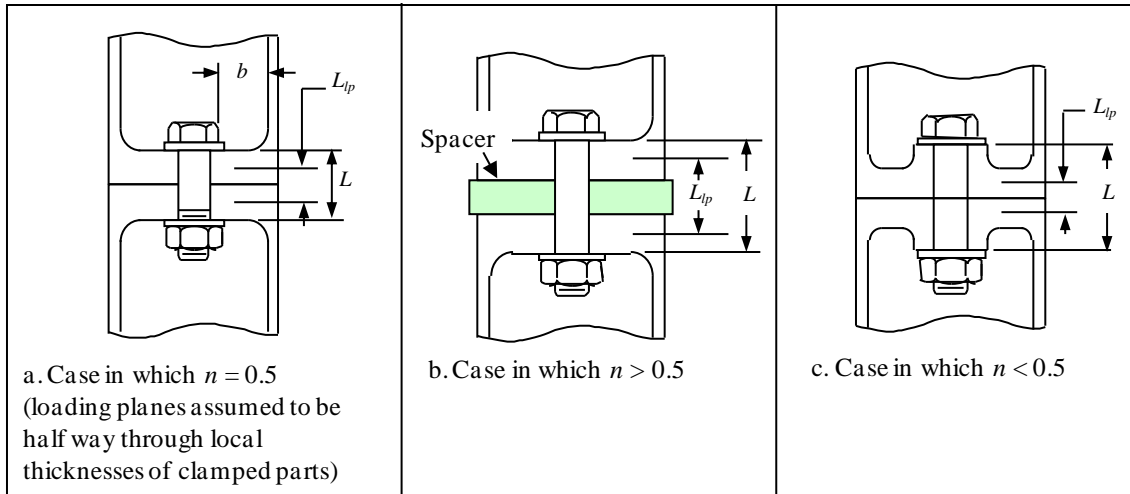

Figure 3—Dimensions Used to Calculate the Geometric Load-Introduction Factor

A.4.1 Derivation of the Stiffness-Based Load-Introduction Factor

A more detailed derivation of the load-introduction and stiffness factors is provided in NASA TM-108377 and is summarized here. Consider a preloaded bolted joint idealized by the following system of springs (represented as stiffness values), as shown in Figure 4, Preloaded Joint Represented by Springs, where k_b is the bolt stiffness, k_c is the joint stiffness, and P_t is the external tensile load. The joint is idealized into 4 regions, each region being demarcated by one of the following features: point 3 being a reference plane; points 2 and 4 at which the external tensile load acts on the joint; point 1 being the interface between the bolt head and clamped members; and point 5 being the interface between the nut (or insert) and clamped members. These four regions, in the most general case, will exhibit different stiffness values (due to varying modulus of elasticity of the individual clamped members within the region, and portion of frustum compression zone contained within the region), and this is represented by the product of the joint stiffness k_c and a variable A, B, C, and D, as shown in Figure 4.

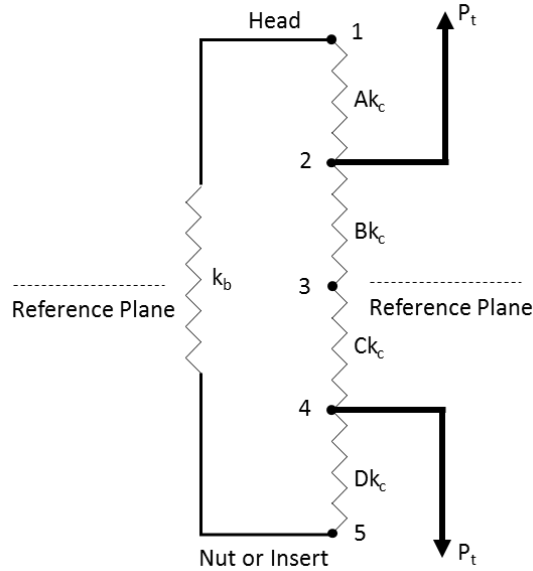

Figure 4—Preloaded Joint Represented by Springs

The four regions should not be confused with the number of clamped members in any given joint. Any number of clamped members, indicated by springs (stiffness values), can be represented by the four regions as shown in Figure 4 using the relationships between spring stiffness in series and the known joint stiffness. For example, writing the stiffness for the region between points 1 and 2 yields Eq. 38. Similar equations can be written for the other regions. The configuration shown in Figure 4 covers any number of clamped members.

$$\sum_{i=1}^N \frac{1}{k_i} = \frac{1}{Ak_c} \quad (\text{Eq. 38})$$

Consider the clamped members from Figure 4 that are relieved upon application of the external load P_t . These clamped members are represented by stiffness values Bk_c and Ck_c . Because the joint is preloaded, these springs act in series. The combined stiffness is denoted as $K_{2-3,3-4}$ and can be determined as

$$\frac{1}{K_{2-3,3-4}} = \frac{1}{Bk_c} + \frac{1}{Ck_c} = \frac{Ck_c + Bk_c}{BCK_c^2} = \frac{B + C}{BCK_c} \quad (\text{Eq. 39})$$

$$K_{2-3,3-4} = \frac{BCK_c}{B + C} \quad (\text{Eq. 40})$$

Consider the remainder of the system of Figure 4 consisting of the clamped members that are compressed upon application of the external load, represented by the stiffness values Ak_c and Dk_c , and the bolt represented by the stiffness k_b . Because the joint is preloaded, the springs act in series, and the combined stiffness is

NASA-STD-5020B

$$\frac{1}{K_{1-2,4-5}} = \frac{1}{Dk_c} + \frac{1}{Ak_c} + \frac{1}{k_b} = \frac{Ak_c k_b + Dk_a k_b + ADk_c^2}{ADk_c^2 k_b} = \frac{(A + D)k_b + ADk_c}{ADk_c k_b} \quad (\text{Eq. 41})$$

$$K_{1-2,4-5} = \frac{ADk_c k_b}{(A + D)k_b + ADk_c} \quad (\text{Eq. 42})$$

The joint idealization shown in Figure 4 can be further simplified using the two stiffness values $K_{2-3,3-4}$ and $K_{1-2,4-5}$ as shown in Figure 5, Preloaded Joint Represented by Two Springs in Parallel, where $K_{2-3,3-4}$ represents the combined stiffness of the clamped members that are relieved by application of an external tensile load, and $K_{1-2,4-5}$ represents the combined stiffness of the clamped members that are compressed by the application of the external tensile load, in addition to the bolt member. The springs shown in Figure 5 act in parallel.

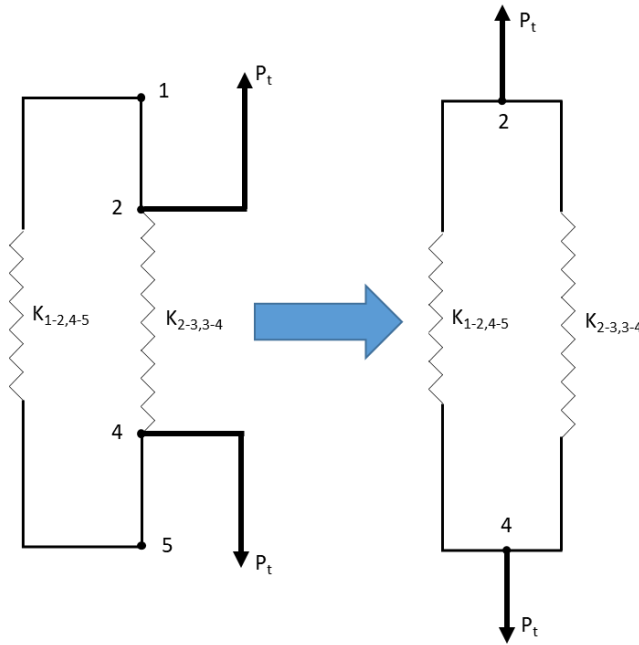

Figure 5—Preloaded Joint Represented by Two Springs in Parallel

The effective stiffness of this entire system shown in Figure 5 can be represented by one stiffness denoted as K_{eff} and written as

$$K_{eff} = K_{2-3,3-4} + K_{1-2,4-5} = \frac{Bck_c}{B + C} + \frac{ADk_c k_b}{(A + D)k_b + ADk_c} \quad (\text{Eq. 43})$$

The relative displacement of points 2 and 4 with respect to each other can be written in terms of the external load as

$$\delta = \frac{P_t}{K_{eff}} \quad (\text{Eq. 44})$$

NASA-STD-5020B

Likewise, the relative displacement of points 2 and 4 with respect to each other can be expressed in terms of the amount of load reacted by the bolt excluding preload, or

$$\delta = \frac{P_{tb} - P_p}{K_{1-2,4-5}} \quad (\text{Eq. 45})$$

Equating Eq. 44 and 45 yields

$$P_{tb} = P_p + \frac{K_{1-2,4-5}}{K_{eff}} P_t = P_p + \frac{B + C}{BC} \left(\frac{k_b}{k_b + k_c} \right) P_t \quad (\text{Eq. 46})$$

that can be expressed as

$$P_{tb} = P_p + n\phi P_t \quad (\text{Eq. 47})$$

where

$$n = \frac{B + C}{BC} \quad (\text{Eq. 48})$$

and

$$\phi = \frac{k_b}{k_b + k_c} \quad (\text{Eq. 49})$$

The LIF represented in Eq. 48 is denoted herein as the stiffness-based LIF and is expressed in terms of the stiffness coefficients of the clamped members being relieved. This LIF may also be expressed in terms of the stiffness coefficients of the clamped members being compressed.

Consider the stiffness of the entirety of clamped members. We have, therefore,

$$\frac{1}{k_c} = \frac{1}{Ak_c} + \frac{1}{Bk_c} + \frac{1}{Ck_c} + \frac{1}{Dk_c} = \frac{BCD + ACD + ABD + ABC}{ABCDk_c} \quad (\text{Eq. 50})$$

that leads to

$$\frac{B + C}{BC} = 1 - \frac{A + D}{AD} \quad (\text{Eq. 51})$$

Substituting Eq. 48 into Eq. 51 yields

$$n = 1 - \frac{A + D}{AD} \quad (\text{Eq. 52})$$

NASA-STD-5020B

The stiffness-based LIF can be expressed by either the stiffness coefficients of the clamped members being relieved by the external tension load, or the stiffness coefficients of the clamped members being further compressed by the external joint tensile load.

A.4.2 Limitation of the Geometry-Based Load-Introduction Factor

Consider the flexibility of the clamped members being relieved, as expressed in Eq. 39. Substituting Eq. 48 into Eq. 39 yields

$$\frac{1}{K_{2-3,3-4}} = \frac{n}{k_c} \quad (\text{Eq. 53})$$

The flexibility of the clamped members being relieved may be expressed in terms of a compression zone of arbitrary shape, $A(x)$, and arbitrary modulus distribution, $E(x)$, where x is the axial coordinate of the joint (i.e., along the length of the fastener), or

$$\frac{1}{K_{2-3,3-4}} = \int_{l_2}^{l_4} \frac{dx}{E(x)A(x)} \quad (\text{Eq. 54})$$

Likewise, for the entire length of the clamped members, one has

$$\frac{1}{k_c} = \int_0^L \frac{dx}{E(x)A(x)} \quad (\text{Eq. 55})$$

Substituting Eq. 54 and Eq. 55 into Eq. 53 yields

$$n = \frac{\int_{l_2}^{l_4} \frac{dx}{E(x)A(x)}}{\int_0^L \frac{dx}{E(x)A(x)}} \quad (\text{Eq. 56})$$

Eq. 56 is a general equation for the stiffness-based LIF. It is assumed that the axial component of the external load and its axial reaction act concentric to the bolt. The axial joint load and its axial reaction load are assumed to be applied uniformly on two parallel cross sections of the compression zone. These compression zone cross sections are assumed to be perpendicular to the bolt axis and separated by a distance equal to the thickness of the clamped members being relieved. The material is assumed to be linear elastic, and Poisson's effects are ignored.

The geometric LIF, denoted herein as n_G , is defined in NSTS 08307 and this NASA Technical Standard as the ratio of the thickness of the joint between force application points and the total thickness of the joint. This may be expressed using the variables of this work as

$$n_G = \frac{l_4 - l_2}{L - 0} \quad (\text{Eq. 57})$$

APPROVED FOR PUBLIC RELEASE – DISTRIBUTION IS UNLIMITED

and depicted in Figure 6, Geometric Load-Introduction Factor.

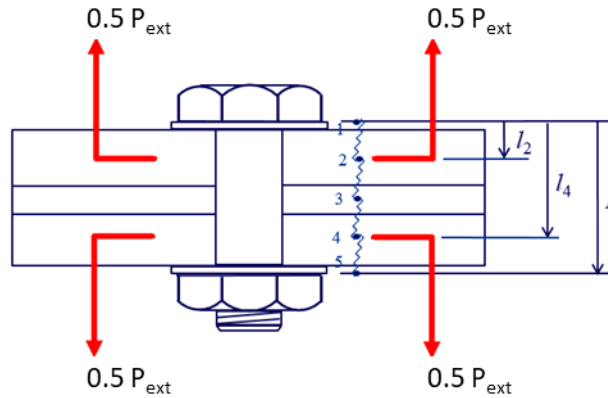

Figure 6—Geometric Load-Introduction Factor

By equating Eq. 56 and Eq. 57, we can express the geometric LIF in terms of the compression zone geometry and modulus distribution, or

$$\frac{l_4 - l_2}{L - 0} = \frac{\int_{l_2}^{l_4} \frac{dx}{E(x)A(x)}}{\int_0^L \frac{dx}{E(x)A(x)}} \quad (\text{Eq. 58})$$

Using the identity

$$\int_a^b dx = b - a \quad (\text{Eq. 59})$$

it can be observed that the only way for Eq. 58 to be satisfied is that E and A not be functions of x , or $E(x)A(x)$ is the constant EA . Therefore, the geometric LIF assumes that the compression zone is limited to a cross-section shape of constant area and of a single value for the modulus of elasticity throughout the length of the joint. In practice, this would be a cylindrical compression zone made of a single material. This conclusion is also supported in VDI 2230. The geometric LIF is inconsistent with the assumptions of a frustum-type compression zone geometry and with clamped members made of materials having different modulus of elasticity.

A.4.3 An Alternative to the Explicit Load-Introduction Factor

The geometric LIF n_G , as defined in NSTS 08307 and in Eq. 37, has been used successfully for many years at NASA to predict the amount of external load allocated to the bolt through the product $n_G\phi$, per Eq. 8. For the bolted joint of Figure 3 (or shown as Figure 10 later in greater detail), the use of the stiffness-based LIF, n , allocates less load to the bolt than the use of the geometric LIF, n_G . Finite element analysis (FEA) may be used to predict the product $n\phi$, and for

NASA-STD-5020B

the joint in Figure 3 (or Figure 10), this product is closer to the value calculated using the stiffness-based LIF n , than is calculated using the geometric LIF n_G . If it is assumed that FEA provides a reasonable approximation of the bolted joint behavior, it follows that the geometric LIF, n_G , allocates too much load to the bolt for this particular joint.

With the continued development of FEA software, obtaining preloaded bolted joint characteristics, including prying effects due to off-axis bolt loading, by explicitly modelling a single bolted joint, has become computationally inexpensive. While it is beyond the scope of this NASA Technical Standard to provide FEA modelling guidance (model fidelity, mesh density, choice of elements, boundary conditions, and material properties), the FEA methodology to determine $n\phi$, consists of the following steps:

1. Explicitly model the clamped members, bolt, nut, and washers to the appropriate level of detail.
2. Use the appropriate linear or nonlinear material properties.
3. Apply a preload to the bolt.
4. For the current preload, apply a range of external loads to the joint.
5. Plot the load reacted by the bolt versus the external tension load component as shown in Figure 7, Predicting the Product $n\phi$ from Finite Element Analysis.
6. Calculate the product $n\phi$, as shown in Figure 7 that is the slope of the line in step 5.
7. Go to step 3 and repeat for another preload level until the range of preloads are adequately covered.

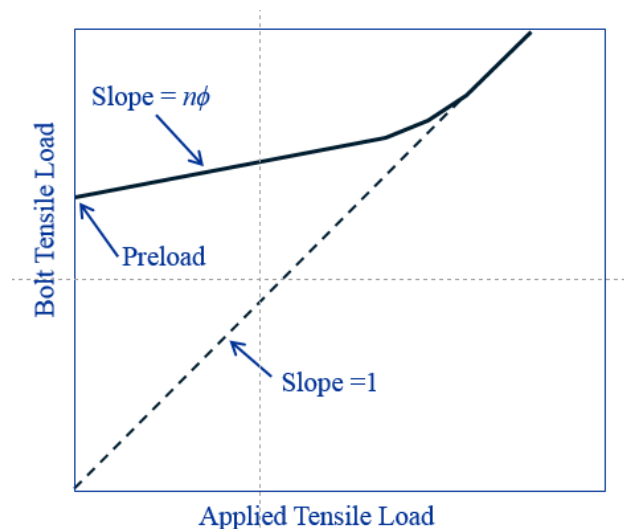

Figure 7—Predicting the Product $n\phi$ from Finite Element Analysis

APPROVED FOR PUBLIC RELEASE – DISTRIBUTION IS UNLIMITED

A.5 Bolt Analysis: Separation before Rupture (Supplement to Section 4.4.5)

Whether separation would occur before rupture can be determined based on test, analysis, or the logic flow in Figure 8, Determining Whether a Joint Separates before Rupture When Loaded Solely in Tension. If analysis is used, it should be based on the assumption of maximum preload.

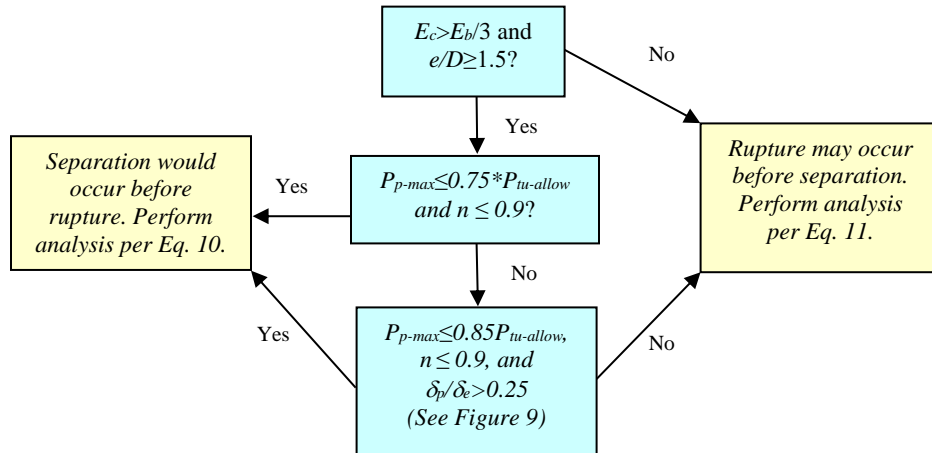

Figure 8—Determining Whether a Joint Separates before Rupture When Loaded Solely in Tension

In Figure 8, E_c is the lowest elastic modulus of clamped parts excluding washers, E_b is the elastic modulus of the bolt material, e is the minimum edge distance (measured from center of hole to closest edge of any clamped part other than washers), δ_p is the plastic deformation of the fastening system at rupture, and δ_e is the elastic deformation of the fastening system at rupture. (See Figure 9, How to Quantify Ductility of a Fastening System from a Tension Test.)

Figure 9 shows a typical load-deflection curve for a bolt tested to failure in tension. The ratio of δ_e to δ_p depends on the fastener and the mating internally threaded part. To determine δ_e and δ_p , the bolt should be tested with an internally threaded part that is of the same specification as is used in the flight assembly in case the hardware combination leads to thread stripping as the mode of failure.

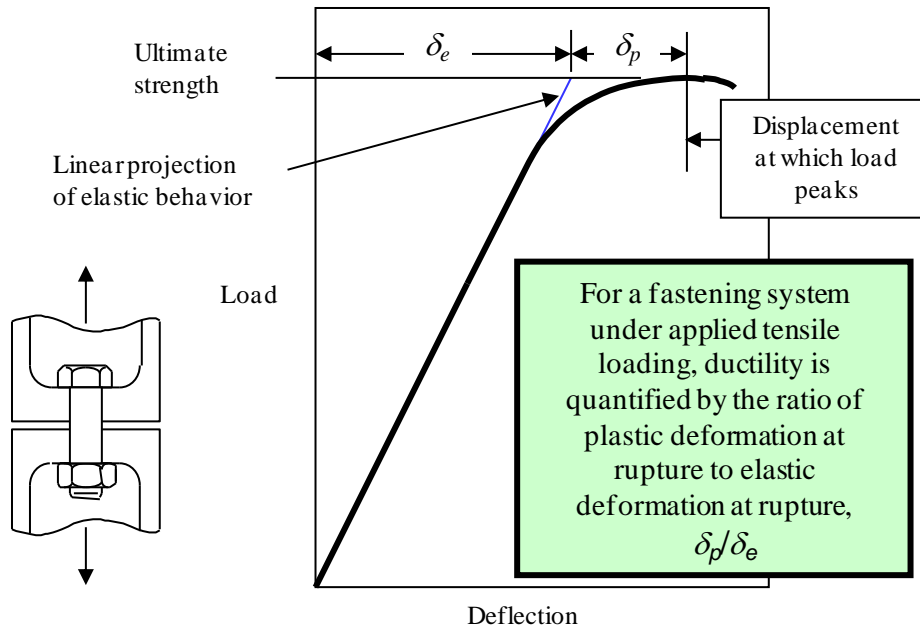

Figure 9—How to Quantify Ductility of a Fastening System from a Tension Test

Figure 8 allows engineers to quickly recognize designs that clearly would separate under applied tensile load before the fastening system ruptures. If the joint would separate before rupture, the tensile bolt load at rupture would be equal to the tensile applied load; and there is no need to include preload or to calculate stiffness of the bolt and stiffness of the clamped material when assessing ultimate strength.

The criteria in Figure 8 were derived from analysis of a joint with a single A-286 bolt and clamped parts made of aluminum alloy. For this combination, the elastic modulus of the clamped material, E_c , is approximately one-third of the elastic modulus of the bolt material, E_b . For any material combination in which E_c is significantly less than $E_b/3$, the total load in a preloaded bolt increases by a larger percentage of applied tensile load than is calculated in this study; and the conclusions made here regarding separation before rupture may not apply. The joint assessed in this study is shown in Figure 10, Preloaded Joint in which the Bolt Load Increases by a Relatively High Percentage of Applied Tensile Load. The geometry and dimensions were selected to maximize $n\phi$, the percentage of applied load by which the bolt load increases prior to separation, with the constraints that $e/D \geq 1.5$ and $E_c > E_b/3$. This joint has a large load-introduction factor, n , that can be calculated as L_{tp}/L , as shown in Figure 3. The joint is shown without washers, as the presence of washers decreases $n\phi$.

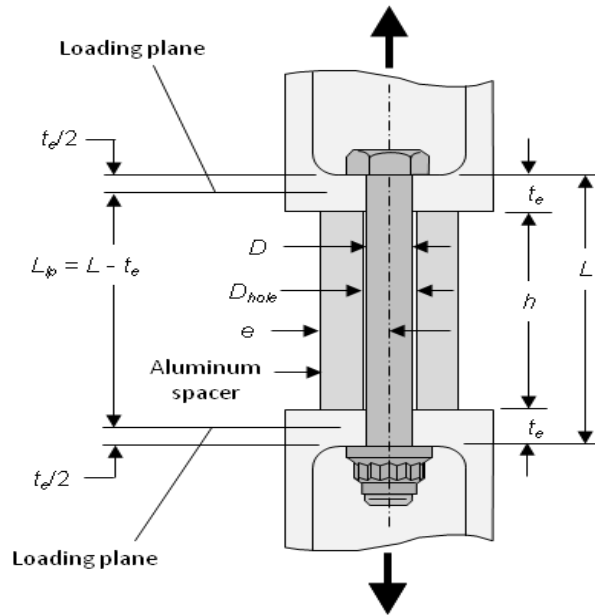

Figure 10—Preloaded Joint in which the Bolt Load Increases by a Relatively High Percentage of Applied Tensile Load

Nonlinear finite element analysis of the joint illustrated in Figure 10—with $E_c = E_b/3$, $e/D = 1.5$, and $n = L_p / L = 0.9$ —shows that $n\phi < 0.25$.

The conclusion is that, for any practical design with $E_c < E_b/3$, $e/D \geq 1.5$, and $n \leq 0.9$, the bolt load increases by no more than 25 percent of the applied tensile load prior to separation.

As shown in Figure 11, Separation before Rupture for a Brittle Threaded Fastening System, when the bolt load increases by 25 percent of the applied tensile load, the joint would separate prior to rupture as long as the preload is not greater than 75 percent of the bolt's ultimate tensile strength. This is the case even if the fastening system exhibits perfectly brittle failure.

Fastening-system hardware made of metal alloys exhibits some degree of ductility prior to rupture. Ductility causes a joint to separate at a lower applied load than would be predicted with linear theory. Consider a joint in which the bolt load increases by 25 percent of the applied tensile load when linear elastic, with preload at 85 percent of the bolt's ultimate tensile strength. For such a joint, separation would occur prior to rupture if the plastic deformation, δ_p , were at least 13.3 percent of the elastic deformation, δ_e , as shown in Figure 12, Separation before Rupture for a Ductile Threaded Fastening System.

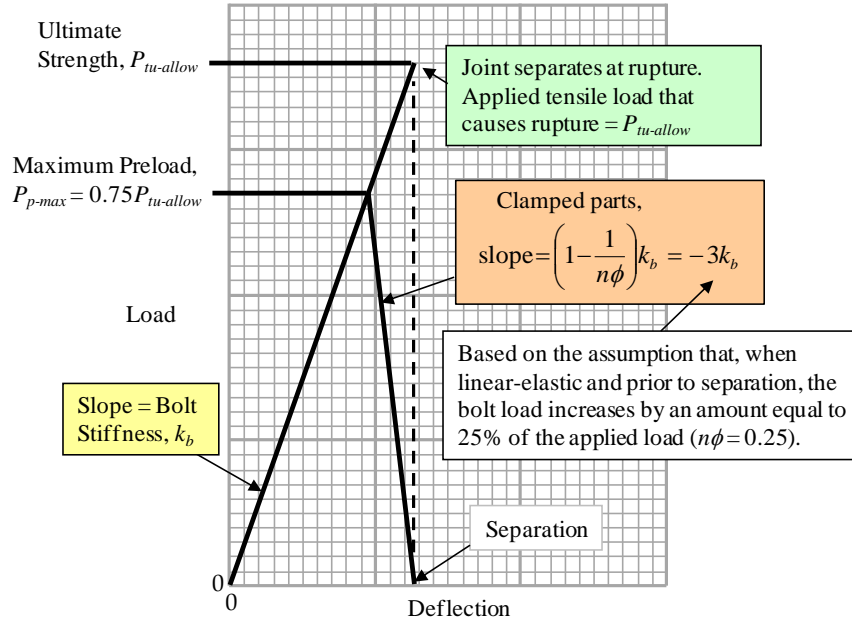

Figure 11—Separation before Rupture for a Brittle Threaded Fastening System

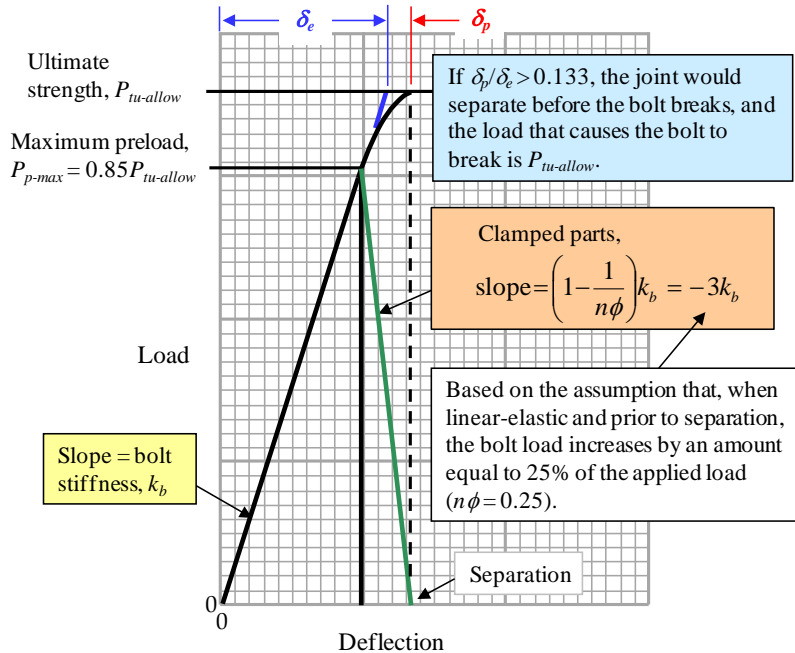

Figure 12—Separation before Rupture for a Ductile Threaded Fastening System

Figure 8 states the criterion that $\delta_p/\delta_e > 0.25$ to draw the conclusion that a joint would separate before the fastening system ruptures when the maximum preload is no greater than 85 percent of the fastening system's allowable ultimate tensile load. The difference between $\delta_p/\delta_e = 0.25$ and $\delta_p/\delta_e = 0.133$ (justified in Figure 12) is intentional to account for potential variation in plastic strain between the actual flight hardware and the hardware tested to rupture when determining δ_p/δ_e .

A.6 Ultimate Margin of Safety for Tensile Loading with Linear Theory (Supplement to Section 4.4.1)

Figures 13, Bolt Tensile Load versus Applied Tensile Load; 14, Separation before Rupture with Linear Theory; and 15, Rupture before Separation with Linear Theory, illustrate the linear mechanics of a preloaded joint under applied tensile load in support of section 4.4.1.

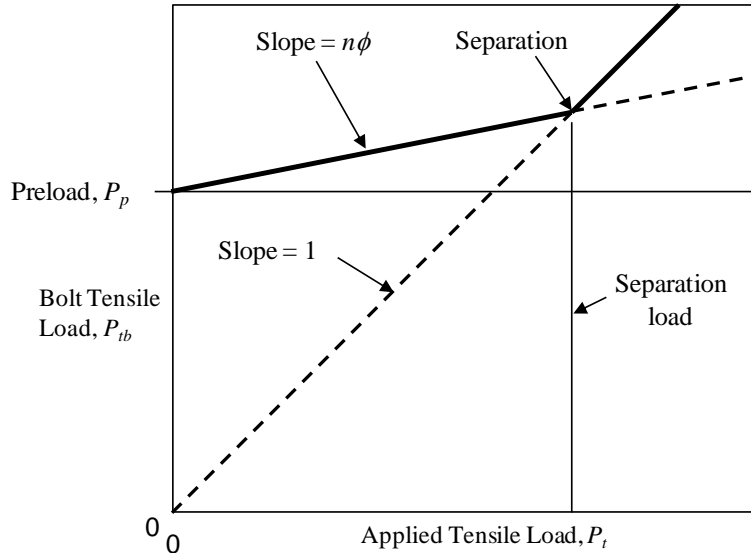

Figure 13—Bolt Tensile Load versus Applied Tensile Load

Eq. 8 applies until either the bolt ruptures or the joint separates. If the joint separates, the bolt load equals the applied load. (See Figure 13.)

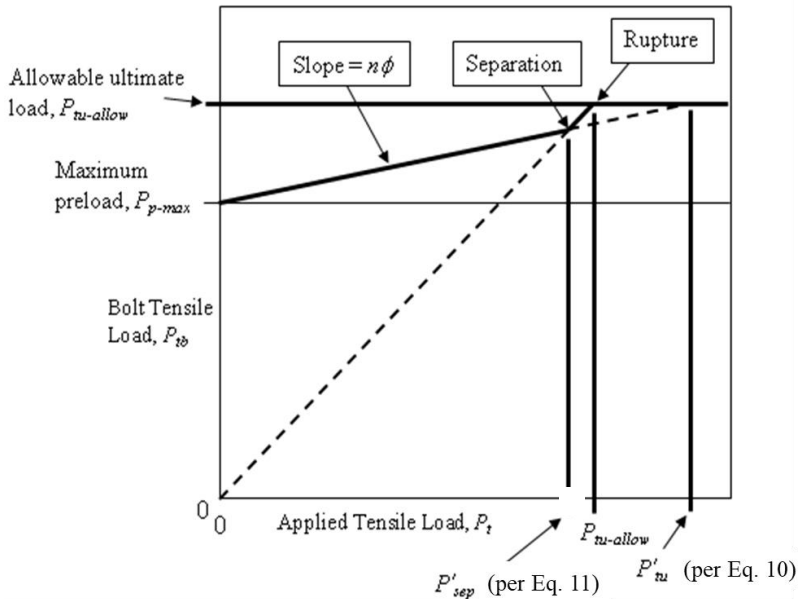

Figure 14—Separation before Rupture with Linear Theory

If separation would occur before rupture, Eq. 10 does not apply and the margin of safety is given by Eq. 6. (See Figure 14.)

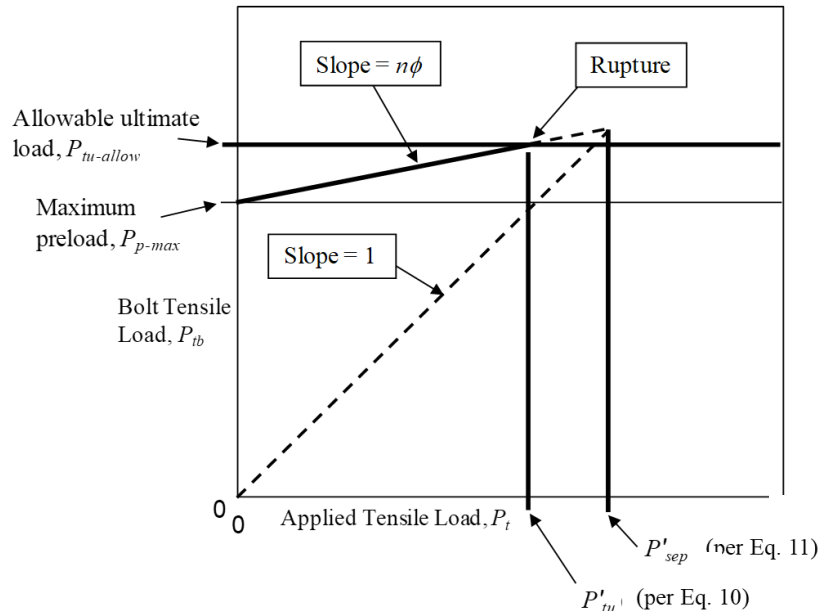

Figure 15—Rupture before Separation with Linear Theory

If rupture would occur before separation, the margin of safety is given by Eq. 7 (see Figure 15).

A.7 Omission of Preload in Shear and Interaction Analyses (Supplement to Sections 4.4.1 and 4.4.4)

Any fastener loaded in shear should have a full diameter body, and the bolt grip should be selected to ensure the full diameter body is in the shear plane. Specified or allowable shear loads for such fasteners are based on shear tests in which the full diameter body is in the shear plane.

When a preloaded fastener is subjected to shear loading, tensile and shear stresses exist simultaneously in the shank. However, if the shear load is increased until the fastener ruptures, the fastener material first yields and the preload relaxes. As a result, the preload does not contribute to failure.

NASA tests performed in 2009 substantiated the above hypothesis for preloaded fasteners loaded in shear only with no threads in the shear plane. Double-shear specimens with steel plates and A-286 3/8-24 (NAS1956C28) bolts were tested to failure, with the full diameter body in the shear plane. Five bolts were tested without preload and five were tested with preload; all fasteners were from the same procurement lot. Those tested with preload were lubricated with Castrol Braycote® 602EF grease and then torqued to 122 N-m (90 ft-lb), that caused yielding in

the fasteners. Prior to assembly, to minimize friction as a shear-load path, the mating surfaces of the steel plates were lubricated with molybdenum disulfide dry-film lubricant. A fresh set of steel plates was used for each test. The average rupture loads for the two configurations tested showed a difference of less than 2 percent.

Similar results were found in tests of A-286 3/8-24 (NAS1956C14) fasteners under simultaneous tensile and shear loading, conducted in 2010 at MSFC. These tests were performed with and without threads in the shear plane. The tests were performed with and without preload; the tests showed preload had an insignificant effect on the failure loads.

The conclusion from these tests is that preload can be disregarded when assessing ultimate strength for a fastener under shear loading or under simultaneously applied tensile and shear loading.

A.8 Theoretical Treatment of Interaction Equations (Supplement to Section 4.4.4)

The interaction equations for ultimate-strength analysis in section 4.4.4 are based on empirical test data rather than a theoretical derivation. However, similar theoretical interaction equations can be derived when shear, tension, and bending across a cross section are considered. This section presents a classical treatment for interaction of shear, tension, and bending. The equations in this section are not intended to replace the interaction equations in section 4.4.4.

Consider a fastener whose shear plane is in the x-z plane and whose tensile direction is along the z-axis. The fastener is loaded in shear only, developing a shear stress τ . The stress tensor associated with the state of stress is given by

$$\sigma = \begin{bmatrix} 0 & 0 & \tau \\ 0 & 0 & 0 \\ \tau & 0 & 0 \end{bmatrix} \quad (\text{Eq. 60})$$

where σ is used to denote the stress tensor (not to be mistaken with a single stress component σ). The principal stresses, given by the eigen values of the stress tensor, are

$$S_1 = 0, \quad S_2 = \tau, \quad S_3 = -\tau \quad (\text{Eq. 61})$$

Using the von Mises yield criterion, one can establish a relationship between the yield stress in tension, F_{ty} , and the yield stress in shear, F_{sy} . The von Mises criterion is

$$(S_1 - S_2)^2 + (S_2 - S_3)^2 + (S_3 - S_1)^2 \leq 2F_{ty}^2 \quad (\text{Eq. 62})$$

Using Eqs. 61 and 62 yields

$$F_{sy} = \frac{F_{ty}}{\sqrt{3}} \quad (\text{Eq. 63})$$

NASA-STD-5020B

It should be noted that F_{sy} is not a typically encountered material property. The usual property encountered is the ultimate shear stress F_{su} . Often, Eq. 63 is assumed to hold at both yield and ultimate conditions, such that

$$F_{su} = \frac{F_{tu}}{\sqrt{3}} \quad (\text{Eq. 64})$$

While Eq. 64 does not have a firm theoretical basis to it, a survey of commonly used materials for fasteners shows that the relationship is typically affirmed.

Now, consider a fastener with a shear τ and tension σ at a point in the cross section. The stress tensor for this state of stress is given by

$$\boldsymbol{\sigma} = \begin{bmatrix} 0 & 0 & \tau \\ 0 & 0 & 0 \\ \tau & 0 & \sigma \end{bmatrix} \quad (\text{Eq. 65})$$

and the principal stresses are given by

$$S_1 = \frac{\sigma + \sqrt{\sigma^2 + 4\tau^2}}{2}, \quad S_2 = \frac{\sigma - \sqrt{\sigma^2 + 4\tau^2}}{2}, \quad S_3 = 0 \quad (\text{Eq. 66})$$

Using Eqs. 62, 63, and 66 yields

$$\left(\frac{\sigma}{F_{ty}}\right)^2 + \left(\frac{\tau}{F_{sy}}\right)^2 \leq 1 \quad (\text{Eq. 67})$$

If Eq. 67 is extrapolated to the ultimate stress condition (which is theoretically incorrect), bending stress is accounted for such that

$$\sigma = \frac{P_{tu}}{A} + f_{bu} \quad (\text{Eq. 68})$$

where A is the cross-sectional area; and using $P_{su} = \tau A$, $P_{su-allow} = F_{su}A$, and $P_{tu-allow} = F_{tu}A$, one has

$$\left(\frac{P_{su}}{P_{su-allow}}\right)^2 + \left(\frac{P_{tu}}{P_{tu-allow}} + \frac{f_{bu}}{F_{tu}}\right)^2 \leq 1 \quad (\text{Eq. 69})$$

Eq. 69 gives an approximation at the ultimate stress condition for a fastener loaded in shear, bending, and tension in the same cross section.

If the bolt is allowed to yield at ultimate design load, one must accommodate the potential for additional load. For simplicity, the case of combined tension and bending for a circular cross

section with radius r is examined. It is assumed to be an elastic, perfectly plastic material with tensile yield stress of F_{ty} . If a pure axial load is applied such that the entire section has yielded, the fully plastic axial force N_p can be computed. Likewise, if the cross section has a pure moment applied such that the upper half is fully yielded to F_{ty} and the lower half is fully yielded to $-F_{ty}$, the fully plastic moment, M_p , can be computed. These values are computed by the integrals

$$N_p = 2 \int_{y=0}^{y=r} \int_{x=-\sqrt{(r^2-y^2)}}^{x=\sqrt{(r^2-y^2)}} F_{ty} dx dy = \pi F_{ty} r^2 \quad (\text{Eq. 70})$$

and

$$M_p = 2 \int_{y=0}^{y=r} \int_{x=-\sqrt{(r^2-y^2)}}^{x=\sqrt{(r^2-y^2)}} F_{ty} y dx dy = \frac{4}{3} F_{ty} r^3 \quad (\text{Eq. 71})$$

Now consider a section with combined tension and bending at collapse such that the stress distribution is as shown in Figure 16, Stress Distribution at Collapse due to Combined Bending and Tension.

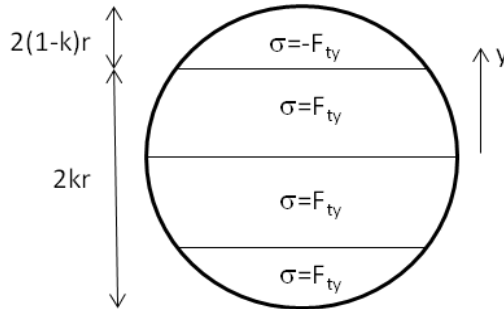

Figure 16—Stress Distribution at Collapse due to Combined Bending and Tension

One can compute the axial force and moment due to the stress distribution shown in Figure 16 as

$$\begin{aligned} N &= 2 \int_{y=0}^{y=-r+2kr} \int_{x=-\sqrt{r^2-y^2}}^{x=\sqrt{r^2-y^2}} F_{ty} dx dy \\ &= 2 F_{ty} \left[2r^2(2k-1)\sqrt{k(1-k)} + r^2 \tan^{-1} \frac{2k-1}{2\sqrt{k(1-k)}} \right] \end{aligned} \quad (\text{Eq. 72})$$

and

$$M = 2 \int_{y=r+2kr}^{y=r} \int_{x=-\sqrt{r^2-y^2}}^{x=\sqrt{r^2-y^2}} F_{ty} y dx dy = \frac{32}{3} F_{ty} r^3 [k(1-k)]^{3/2} \quad (\text{Eq. 73})$$

NASA-STD-5020B

If either Eq. 72 or Eq. 73 is solved for k , an interaction equation could be written relating the allowable axial load and moment at collapse. The closed-form solution is shown by Eq. 74. (See Stronge & Yu, “Dynamic Models for Structural Plasticity.”)

$$\left\{ \cos \left[\frac{\pi N}{2N_p} - \left(\frac{M}{M_p} \right)^{1/3} \sqrt{1 - \left(\frac{M}{M_p} \right)^{2/3}} \right] \right\}^3 - \left| \frac{M}{M_p} \right| = 0 \quad (\text{Eq. 74})$$

By comparison, if a rectangular cross section is considered, a simpler expression relating moment and axial load at collapse is found such that

$$\frac{M}{M_p} + \left(\frac{N}{N_p} \right)^2 = 1 \quad (\text{Eq. 75})$$

A comparison between Eqs. 74 and 75 is shown in Figure 17, Comparison of Interaction between Circular and Rectangular Cross Sections at Collapse. As can be seen from the figure, there is little difference between the two closed-form solutions. For simplicity, it can be assumed that the interaction equation given by Eq. 75 can be applied to circular cross sections indicative of fasteners.

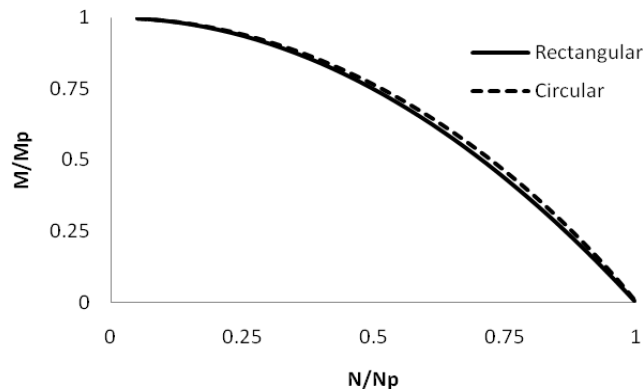

Figure 17—Comparison of Interaction between Circular and Rectangular Cross Sections at Collapse

To account for shear, a rectangular cross section is used. This simplifies the problem and allows for a simple closed-form solution. For a rectangular cross section, the fully plastic axial force and fully plastic moment are given by

$$N_p = F_{ty}bh, \quad M_p = \frac{F_{ty}bh^2}{4} \quad (\text{Eq. 76})$$

From Eq. 67, the tension-carrying capability of the cross section is reduced due to an applied shear. Eq. 67 can be rewritten in terms of shear Q and fully plastic shear Q_p such that

NASA-STD-5020B

$$\left(\frac{\hat{F}_{ty}}{F_{ty}}\right)^2 = 1 - \left(\frac{Q}{Q_p}\right)^2, \quad \text{where } \frac{Q}{Q_p} = \frac{\tau A}{F_{sy}A} \quad (\text{Eq. 77})$$

and \hat{F}_{ty} is the reduced allowable load due to the shear load. Under combined shear, tension, and bending, the peak tensile stress is limited to \hat{F}_{ty} . Using the same methodology that led to Eqs. 72 and 73, the axial force and moment acting on the cross section due to \hat{F}_{ty} are

$$N = \hat{F}_{ty}bh(2k - 1), \quad M = \hat{F}_{ty}bh^2(1 - k)k \quad (\text{Eq. 78})$$

Solving for k and combining Eq. 76 to 78 at collapse yields

$$\left(\frac{Q}{Q_p}\right)^2 + \left(\frac{N}{N_p}\right)^2 + \frac{M}{M_p} \sqrt{1 - \left(\frac{Q}{Q_p}\right)^2} = 1 \quad (\text{Eq. 79})$$

Eq. 79 can be simplified and rewritten as

$$\left(\frac{P_{su}}{P_{su-allow}}\right)^2 + \left(\frac{P_{tu}}{P_{tu-allow}}\right)^2 + \frac{f_{bu}}{F_{bu}} \leq 1 \quad (\text{Eq. 80})$$

In Eq. 80, the more theoretically appropriate F_{tu} has been replaced with the term F_{bu} . It is not uncommon for practitioners to implement a higher allowable based on plastic bending rather than the tensile allowable. Doing so is less conservative, though this approach is accepted due to the conservatism that led to the development of the interaction equation, namely the use of a linear elastic, perfectly plastic material response.

A.9 Determining if Fastener Yielding is Detrimental for Separation or Joint Slip (Supplement to Section 4.4.2)

In a typical joint with preload generated by torque control, fastener yielding under combination of preload and applied load is not detrimental for separation. Rationale:

a. As shown in Figure 18, Effect of Fastener Yielding on the Separation Load, fastener yielding causes the separation load to be lower than is predicted based on linearly calculated bolt stiffness and clamp stiffness. However, section 4.4.3 requires that the design separation load not exceed minimum preload, which is less than the actual separation load shown in the figure. Thus, fastener yielding that occurs under a given applied load does not affect separation analysis for that load.

b. Figure 19, Loss of Preload Resulting from Fastener Yielding, shows an example of the loss in preload associated with yielding under an applied load equal to the separation load. Because of strain hardening, reapplication of the same load does not cause further yielding and

NASA-STD-5020B

the separation load is unchanged. Thus, fastener yielding that occurs under an applied load that does not cause separation is not detrimental for separation under repeated loading.

c. Figure 20, Fastener Yielding under an Applied Load that Exceeds the Separation Load, shows a situation in which yielding occurs under an applied load that separates the joint. (This situation is possible if the yield factor of safety is greater than the separation factor of safety, in which case the design criteria allow the design yield load to exceed the minimum preload.) Once the applied load is removed, the residual preload is considerably less than the original preload, and the separation load also is below the original preload.

Such yielding can be detrimental for separation if the new separation load is below the minimum preload calculated with Eq. 4. This may be the case if preload is accurately controlled through a method such as ultrasonically measuring the bolt's change in length. In such a situation, a positive margin of safety for fastener yielding using Eq. 15 ensures the fastener will not yield after separation under the design yield load.

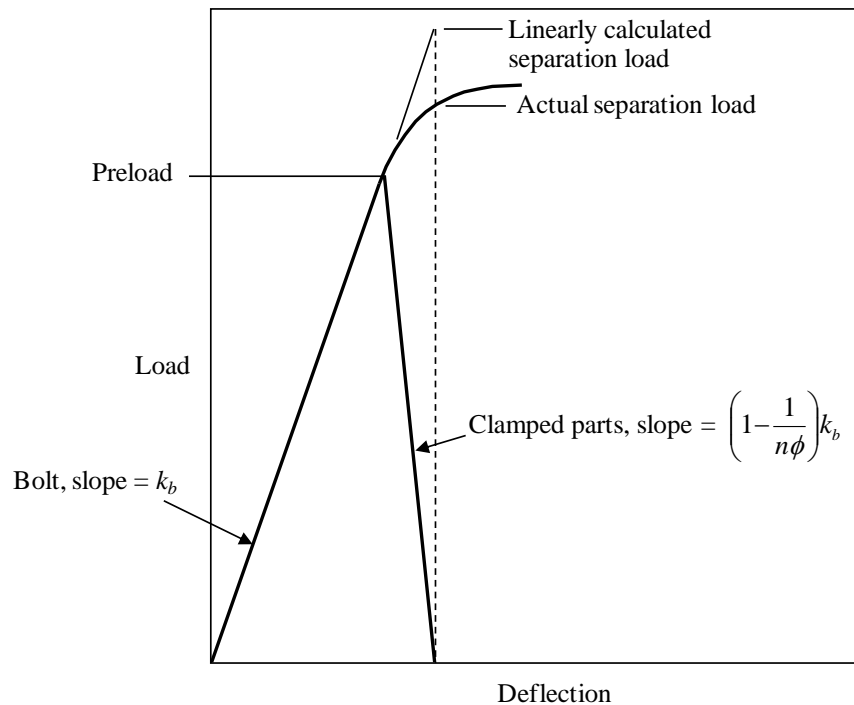

Figure 18—Effect of Fastener Yielding on the Separation Load

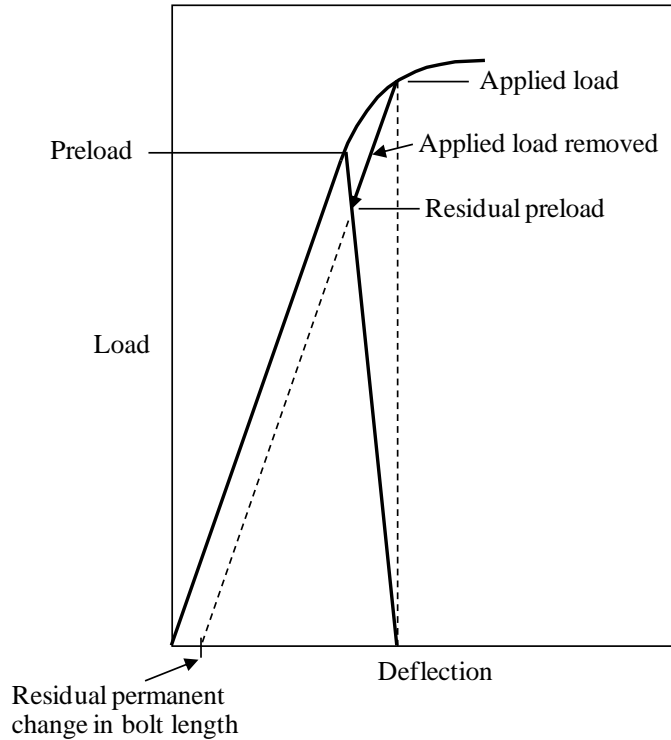

Figure 19—Loss of Preload Resulting from Fastener Yielding

With torque control, there is a wide range between the maximum and minimum preloads calculated per section 4.3.1. Section 4.4.3 specifies a criterion that the design separation load not exceed the calculated minimum preload. If this criterion is satisfied, the design yield load, using typical yield factors of safety for flight hardware, would not exceed the maximum preload and would not cause separation. This premise can be verified by calculation of a yield margin of safety using Eq. 15, if desired.

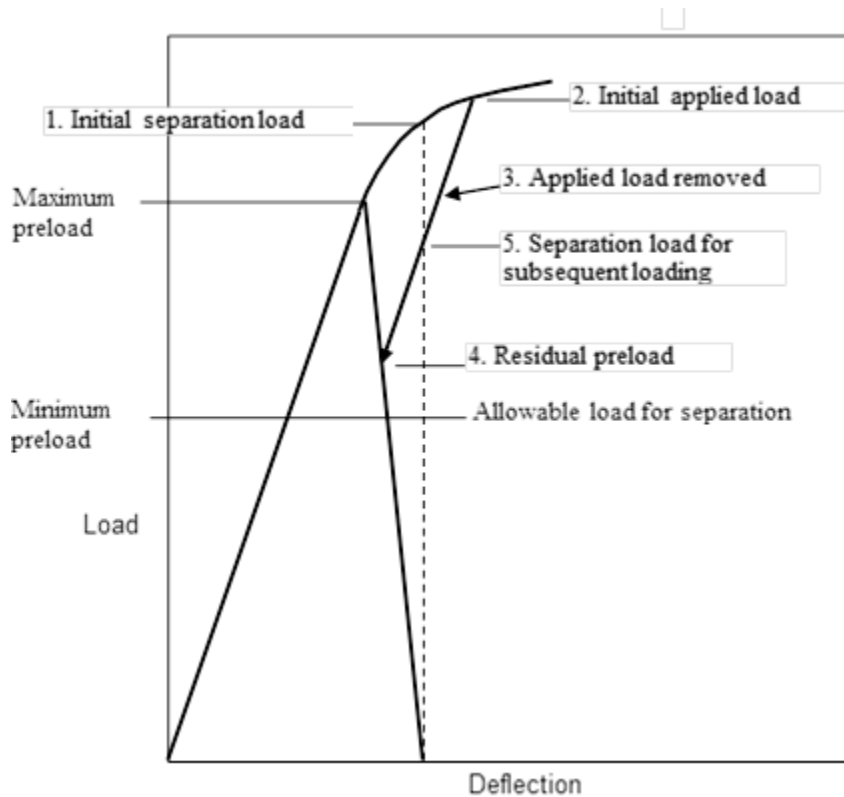

Figure 20—Fastener Yielding under an Applied Load that Exceeds the Separation Load

A possible exception to the above conclusions arises if preload changes significantly under temperature extremes. For example, if preload increases with temperature and yielding occurs at the maximum design temperature, and then the joint later reaches its minimum design temperature, the residual preload may be inadequate to prevent separation under the co-existing design separation load. A recommended criterion for avoiding this situation is to ensure the maximum preload calculated with Eq. 3 does not exceed the fastener’s allowable yield tensile load.

The guidance for determining whether fastener yielding is detrimental for separation also applies to the issue of whether fastener yielding is detrimental for joint slip. In addition, consideration must be given to the situation in which the fastener yields under one loading event such as ground test or liftoff, followed by the design yield shear load in a later event such as maximum air loads during launch. When relying on friction for an alignment-critical joint, it may be wise to assume fastener yielding is detrimental and satisfy the criteria given in section 4.4.2.

A.10 Margin of Safety for Joint Slip (Supplement to Sections 4.4.1 and 4.4.6)

To be consistent with separation analysis (see Appendix A.11), slip analysis is based on the assumption that the clamp force in a preloaded joint is reduced by 100 percent of the applied tensile load. When a joint is concentrically loaded with shear (load passes through bolt-pattern

NASA-STD-5020B

centroid) and simultaneously loaded in tension, using fasteners of the same type and with the same nominal preload, the friction load, P_f , that can be developed is

$$P_f = \mu(n_f P_{p-nom} - P_{t-joint}) \quad (\text{Eq. 81})$$

where $P_{t-joint}$ is the total applied tensile load acting on the joint.

Calculation of a margin of safety for slip—that must account for minimum preload, limit loads, and a factor of safety—is not straightforward in such a case. Based on the assumption that, if the applied tensile and shear loads were to increase, they would do so proportionally; one can solve for the proportionality constant, a , that causes a zero-margin condition

$$\frac{\mu(n_f P_{p-min} - a \cdot FS \cdot P_{tL-joint})}{a \cdot FS \cdot P_{sL-joint}} - 1 = 0 \quad (\text{Eq. 82})$$

where μ is the coefficient of friction, FS is the appropriate factor of safety for the failure mode affected by slip, $P_{sL-joint}$ is the total limit shear load acting on the joint, and $P_{tL-joint}$ is the total limit tensile load acting on the joint. Solving for a gives

$$a = \frac{\mu n_f P_{p-min}}{FS(P_{sL-joint} + \mu P_{tL-joint})} \quad (\text{Eq. 83})$$

Because a is the scaling factor applied to the external loads that causes a zero-margin condition, the margin of safety for slip is

$$MS_{slip} = a - 1 = \frac{\mu n_f P_{p-min}}{FS(P_{sL-joint} + \mu P_{tL-joint})} - 1 \quad (\text{Eq. 84})$$

When no external tensile load is applied, Eq. 84 reduces to

$$MS_{slip} = \frac{\mu n_f P_{p-min}}{FS \cdot P_{sL-joint}} - 1 \quad (\text{Eq. 85})$$

Eqs. 84 and 85 only apply to a joint that is concentrically loaded in tension and shear, has equal nominal preload for all fasteners, and equivalent fastener sizes. When any of these conditions are violated, these equations cannot be used; and an analysis considering these effects must be performed. An example when Eqs. 84 and 85 would not apply is eccentrically loaded joint where the shear produces a resultant torque about the bolt-pattern centroid. A finite element analysis or test can be used to verify that the joint does not slip under such a condition. Another acceptable approach is to assess slip individually at each fastener location as follows:

$$MS_{slip} = \frac{\mu P_{p-min}}{FF \cdot FS \cdot (P_{sL} + \mu P_{tL})} - 1 \quad (\text{Eq. 86})$$

APPROVED FOR PUBLIC RELEASE – DISTRIBUTION IS UNLIMITED

NASA-STD-5020B

where P_{sL} is the limit shear load for the fastener and P_{tL} is the limit tensile load for the fastener. Note that, with this approach, a non-negative margin of safety for slip must be shown for each fastener, given that the limit shear and tensile loads may not peak on the same fastener.

A.11 Margin of Safety for Bolted Joint Separation (Supplement to Section 4.4.3)

The numerator in Eq. 19 is P_{p-min} . Although a bolted joint can withstand an applied tensile load somewhat higher than the preload before separation occurs, it is difficult to conservatively calculate the true separation load. This is true because most methods of analysis used to calculate load sharing in a preloaded bolted joint using bolt stiffness, clamped-material stiffness, and loading-plane factor have been derived from test data with the intention of conservatively predicting the total bolt load. Any such method that conservatively predicts bolt load over-predicts the separation load. In addition, if a preloaded bolt begins to yield under applied tensile load, separation occurs at a lower applied load than linear theory predicts.

In recognition of the above considerations, it was decided that the separation load should be set equal to minimum preload.

A.12 Load Redistribution within a Fastened Joint

When analysis is used to assess the structural integrity of an individual fastener or a group of fasteners in a fastened joint, considerations should be made for the potential of loads to redistribute either due to geometric design features or failure modes. In this section, the following examples are used to illustrate the potential for load redistribution:

- Geometric: Excessive radial clearance between the fastener and clearance hole-bearing surface.
- Localized yielding: Design of yield critical joints compared to bearing critical joints.
- Separation: Changing load paths or mechanical response due to separation.
- Slipping: Distribution of clamp force in the group of fasteners.

A.12.1 Load Redistribution Due to Geometric Features

As an example of load redistribution due to geometric features, a simple lug that is attached by four fasteners is examined, as shown in Figure 21a, Lug with Clearance Holes Example. The fasteners have some amount of radial clearance when situated into the attachment holes of the lug, and the fasteners are not located in the same position relative to the holes. A load is applied such that there are in-plane components of shear and a torque about the bolt pattern centroid. If the lug slips relative to the fasteners, it is likely that the load will redistribute; and the redistribution will be a function of the clearance between the fastener and part, the ductility of each component, and the direction and magnitude of the applied load. For the example shown in Figure 21a, a plausible deformed configuration is shown in Figure 21b, Rigid Body Response for Lug with Clearance Holes, where at most three of the four fasteners may be loaded.

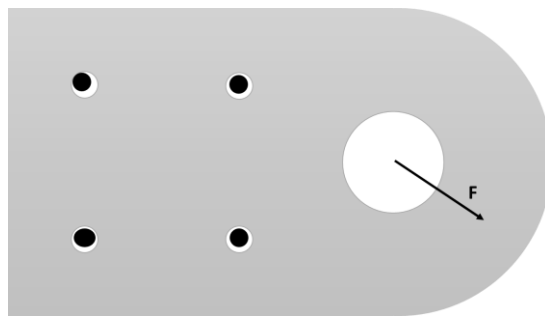

Figure 21a—Lug with Clearance Holes Example

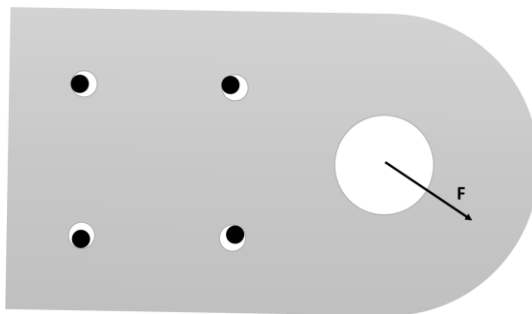

Figure 21b—Rigid Body Response for Lug with Clearance Holes

For connections that are expected to react shear, to minimize the ramifications of load redistribution, reducing the radial clearances between the hole and fastener surfaces is recommended. If this cannot be accomplished, it should be considered non-conservative to assume the load is equally shared between fasteners. Testing or additional analysis should conservatively bound the expected response of the design.

A.12.2 Load Redistribution Due to Localized Yielding

For the lug shown in Figure 21a, it was hypothesized that potentially only three of four fasteners may be loaded due to the clearance. If the lug is designed to be bearing critical such that the lug material yields before shear failure of the fasteners, some local yielding at a fastener location can cause a redistribution in load. If there is excessive yielding for the example shown in Figure 21a, eventually all fasteners in the pattern may react the forces applied to the lug. However, excessive yielding at a location can have the negative consequence of greater-than-anticipated reactions at other fastener locations. As an example, consider the simple geometry of Figure 22a, Simplified Two-Bolt Plasticity Model, where a component is loaded with some force and reacted at two locations. The bolt-to-component interface is modeled as a spring attached to ground. It is assumed that the bolt closer to the applied force will initially react a greater percentage of the load, and the spring constant k_1 is assumed to be 50 percent greater than k_2 , and both springs are assumed to have a bilinear force-displacement response such that at a prescribed force magnitude, no additional load is reacted, as shown in Figure 22b, Assumed Plasticity Model.



Figure 22a—Simplified Two-Bolt Plasticity Model

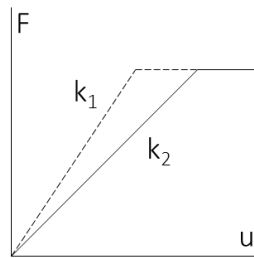

Figure 22b—Assumed Plasticity Model

When this model is loaded, the system response will differ from the elastic solution when the nonlinear response is considered. Figure 23, Difference in Response between Elastic and Elastic-Plastic Model, shows a representative system response, where for a given load, the displacement may be severely under-predicted if the elastic-plastic behavior is not implemented. If this were an alignment critical design, not accounting for the effects of localized yielding could lead to functional performance issues.

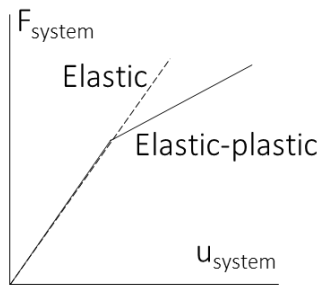

Figure 23—Difference in Response between Elastic and Elastic-Plastic Model

A.12.3 Load Redistribution Due to Separation

When separation is considered, there is load redistribution similar to when plastic effects are considered. However, in this case when separation occurs, the slope of the applied load and bolt tensile load curve changes such that additional applied tensile load is directly additive to the bolt load, as demonstrated in Appendix A.6.

To demonstrate the effects of separation, a simple two-joint system is considered, as shown in Figure 24, Two-Joint Separation Model. A shear load is applied some distance above the bolted interface plane such that a global heel-toe reaction is envisioned. The fitting on the left side will be loaded in tension whereas the right-side fitting is in compression. The load is transferred to the fittings assuming an infinitely rigid connection. The bolts are considered to be steel, whereas the fitting members are aluminum. For simplicity, the bolts are assumed to have a solid body with a diameter of $d = 0.25$ in and a head and nut diameter of $d = 0.50$ in, and each aluminum member is 0.50 in thick and has a 0.001-in radial clearance to the bolt body. In this example, the bolts are assumed to be preloaded to $F_{pre} = 3135$ lb, with the exception of the first bolt on the left side that is assumed to be preloaded only to $F_{pre} = 2090$ lb.

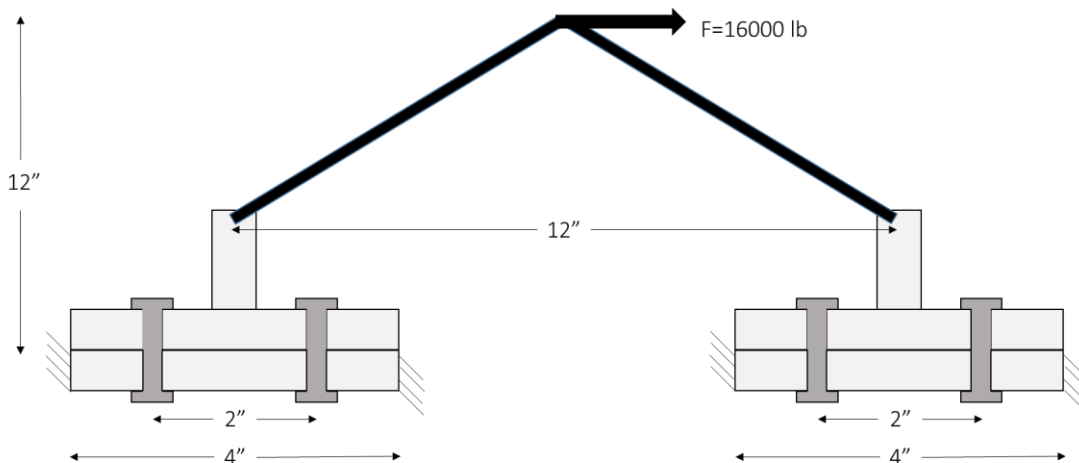

Figure 24—Two-Joint Separation Model

NASA-STD-5020B

Using the frustum method with a cone angle of 25 degrees to determine the joint stiffness yields a stiffness ratio of $\phi = 0.314$ for the joint geometry. Also, it is assumed that the load-introduction factor is equal to $n = 0.5$. With a preload of $F_{pre} = 2090$ lb, the interface at the first bolt would be expected to separate locally at approximately

$$P'_{sep} = \frac{F_{pre}}{1 - n\phi} = \frac{2090}{1 - 0.5 * 0.314} = 2479 \text{ lb}$$

If we assume that both bolts on the left fitting separate at this load (or that both are preloaded to $F_{pre} = 2090$ lb), a globally applied load of $F = 4958$ lb would be calculated to cause separation of the left fitting. However, if we assume that the left fitting will separate based on the total preload of $F_{pre} = 2090$ lb for one bolt and $F_{pre} = 3135$ lb for the other bolt, the left joint would be expected to be fully separated at a load of

$$P'_{sep} = \frac{F_{pre}}{1 - n\phi} = \frac{2090 + 3135}{1 - 0.5 * 0.314} = 6198 \text{ lb}$$

that leads to a globally applied load of $F = 6198$ lb.

The joint picture above was analyzed using a finite element model that includes touching contact between the bolt and joint members. All contact pairs are assumed to be frictionless. Figure 25, Bolt Forces during Loading of Two-Joint Separation Model, shows individual bolt forces as a function of the externally applied load. The analysis results suggest that partial separation begins below 4300 lb, and full separation of the local region near the first bolt occurs at around 5100 lb. As the first bolt begins to separate, the load redistributes somewhat and the bolt second from the left experiences a slight increase in load. Upon full separation of the first bolt, the load in the second bolt increases more until it too is fully gapped at an external load below the 6198 lb prediction from hand analysis.

The load redistribution within this example has the effect of modifying the system stiffness. The system response is shown in Figure 26, System Stiffness due to Separation and Yielding, in which a baseline analysis assuming no separation is compared to the case where separation can occur. Additionally, a comparison is made to a model that implements typical elastic-plastic behavior for the aluminum and steel members. All models converge to similar response at low load; but when separation occurs, there is a clear change in stiffness. Such effects should be assessed in the design to verify that the functional requirements, both structural and non-structural, are being met. For example, with this example, the change in stiffness could affect the vibrational response of a structure.

NASA-STD-5020B

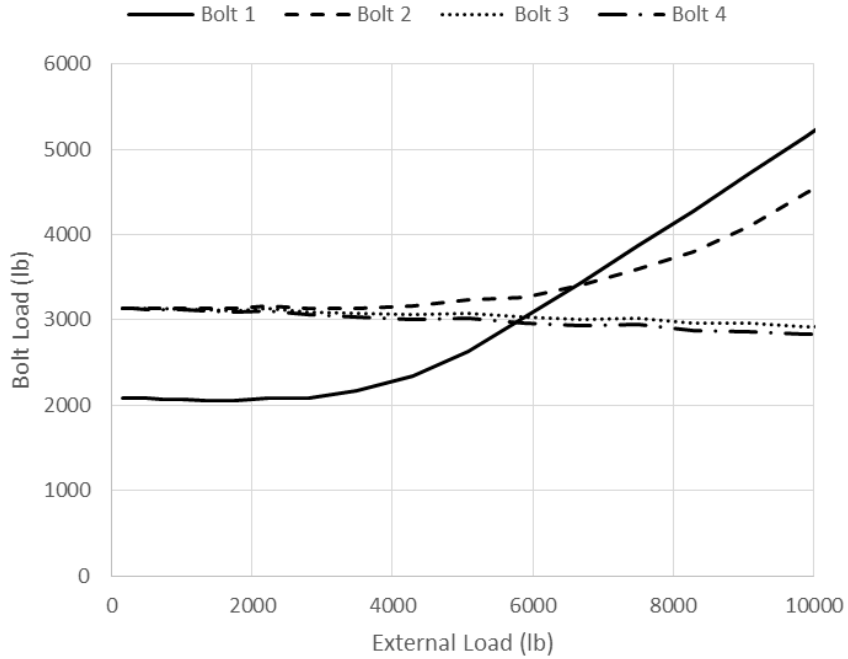

Figure 25—Bolt Forces during Loading of Two-Joint Separation Model

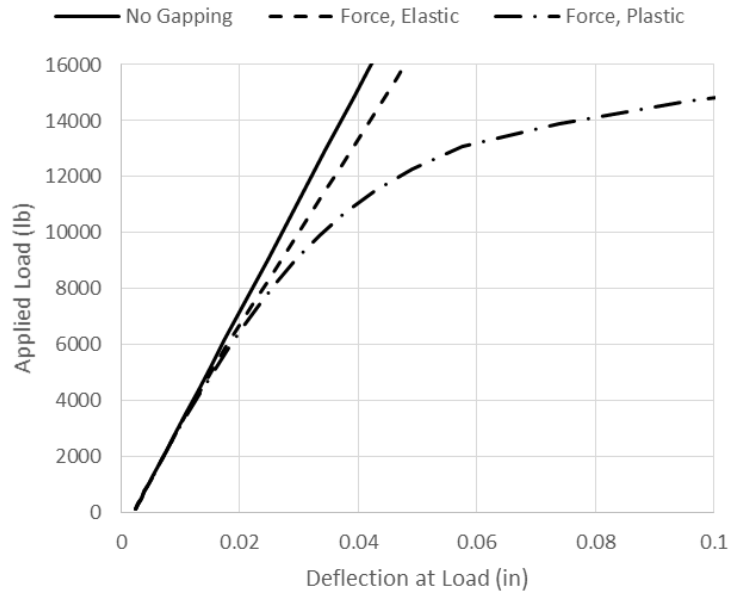

Figure 26—System Stiffness Due to Separation and Yielding

APPROVED FOR PUBLIC RELEASE – DISTRIBUTION IS UNLIMITED

A.12.4 Load Redistribution Due to Slipping

The scenarios described above can act together to cause sufficient load redistribution such that a bolted joint will slip at a load less than predicted. If we consider the case of the two-joint separation model shown in Figure 24 and assume a coefficient of friction of 0.10 between all surfaces, an estimate for the load at which slippage occurs can be determined. A nonlinear finite element model is used to estimate the shear forces acting on each bolt as a function of externally applied shear. Figure 27, Shear Load Acting on Bolt from Slip Analysis, shows that the outer bolts slip first and react the externally applied shear load. It is not until a higher external load that the other fasteners react shear load.

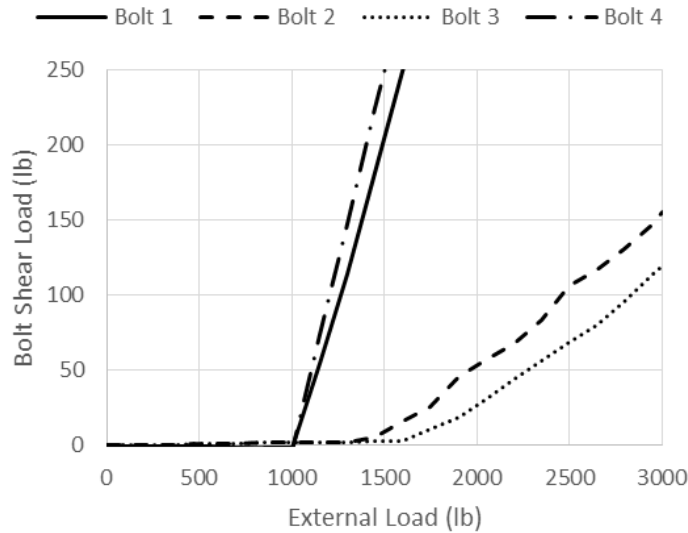

Figure 27—Shear Load Acting on Bolt from Slip Analysis

Figure 28, Contact Status at the Faying Surface during Slip, shows the predicted regions of contact at the faying surface for the two halves of the joint, where a light gray color indicates compressive contact. At initial preload conditions, the compression at the faying surface is consistent except for the left-most fastener location (due to lower preload). Initial slipping occurs at approximately $F=1000$ lb, where the compression region on the left half of the joint has diminished. After the second slip load near $F=1500$ lb and beyond, the contact conditions change significantly.

NASA-STD-5020B

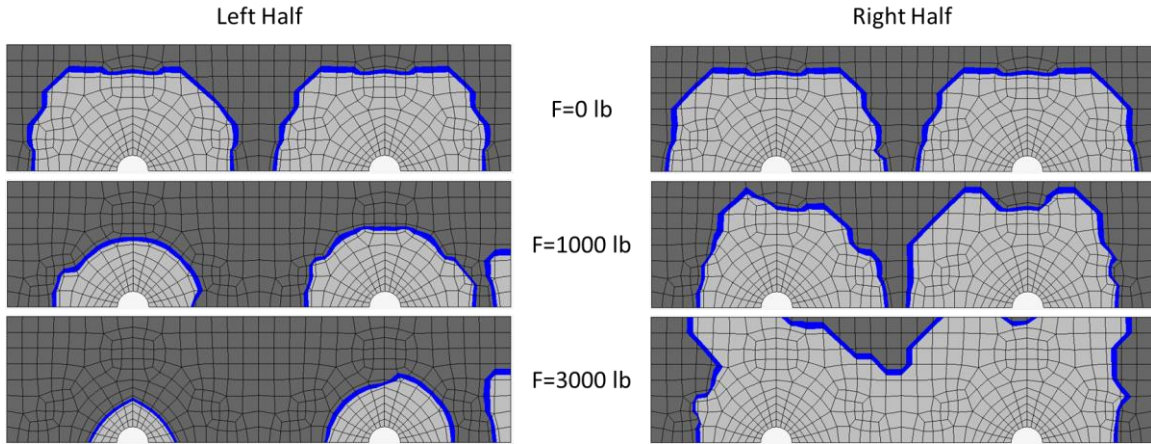

Figure 28—Contact Status at the Faying Surface during Slip

APPENDIX B

BEST PRACTICES FOR LOCKING FEATURES

B.1 Purpose of Appendix B

This Appendix provides best practices for locking features.

B.2 Background and Introduction

Threaded fasteners are often used in dynamic environments, including vibration, shock, thermal cycles, and pressure cycles. As a result, threaded fasteners often experience dynamic tensile, shear, and moment loads. A properly designed preloaded joint will have sufficient preload (taking into account torque-tension uncertainty, embedment, etc.) such that the dynamic loads have little or no effect on joint integrity. However, if unexpected dynamic loads or temperature cycles are encountered that are sufficient to cause cyclic slip (localized or complete; see Pai and Hess (2002)) at the fastener thread or bearing surfaces, then fastener loosening, preload loss, and component/fastener loss can occur.

The friction at fastener thread and bearing surfaces in a properly designed preloaded joint is the mechanism that prevents slip in a preloaded joint. This friction is proportional to preload. As a result, preload is often referred to as a primary locking feature in a preloaded joint.

In an effort to eliminate or reduce loosening and possible failure in the event of unexpected dynamic loads, temperature excursions, or design errors or to provide locking in fasteners without preload (e.g., fasteners in some electrical applications), additional locking mechanisms or features are often utilized or required. These include the following: (a) mechanical locking devices such as cotter pins and safety wire; (b) prevailing torque devices such as fasteners with a deformed portion of threads or a polymer patch; (c) adhesives such as anaerobic adhesive; and (d) free spinning locking devices such as fasteners with serrated bearing surfaces or lock washers. Such devices or features are often considered secondary locking features when used in a preloaded joint with preload providing primary locking.

Experience has shown these locking features have the following characteristics:

- a. Mechanical locking features such as cotter pins and safety wire allow some rotation until abutment that results in some loss of preload.
- b. In severe vibration and shock environments, the main feature of prevailing torque locking devices is to prevent complete separation and loss of fasteners (i.e., provide foreign object debris protection), not to maintain preload.
- c. With adequate cure, adhesives perform comparatively well in maintaining preload even in severe vibration and shock environments.

NASA-STD-5020B

d. Free spinning locking devices such as fasteners with serrated bearing surfaces perform comparatively well, but their function is dependent on preload. Because of this dependence on preload, free spinning locking devices cannot be used as a secondary locking feature if preload is used for primary locking. Loss of preload removes both locking features. In addition, serrations can damage joint bearing surfaces. Free spinning split lock and tooth lock washers provide minimal, if any, locking.

e. Figure 29, Locking Feature Selection Flowchart, provides basic guidance for locking feature selection. The following sections of this appendix provide more information and guidance on locking features and devices, including appropriate specifications, best practices, limitations, and installation.

B.3 Best Practices for Mechanical Locking Features

Mechanical locking features include, but are not limited to, cotter pins, safety wire, and safety cable. These parts are covered by industry standards such as NASM 33540.

Mechanical locking features provide a reliable locking method for joints but come with drawbacks and design details that must be considered. Most mechanical locking features require additional parts that may increase the design's complexity and weight. Sharp edge hazards from mechanical locking features are not acceptable for designs in crew translation paths for crewed spaceflight vehicles or crew actuated joints (EVA requirements are outlined in JSC-28918, EVA Design Requirements and Considerations). Mechanical locking features posing sharp edge hazards may be mitigated using encapsulation methods with room-temperature vulcanizing silicones or epoxy; however, materials must be compatible with their use environment.

Mechanical locking features such as cotter pins and safety wire allow some rotation until abutment. This can lead to loss of preload. As an example, Light (1983) presents data showing 30-percent loss of preload under severe vibration conditions from this rotation.

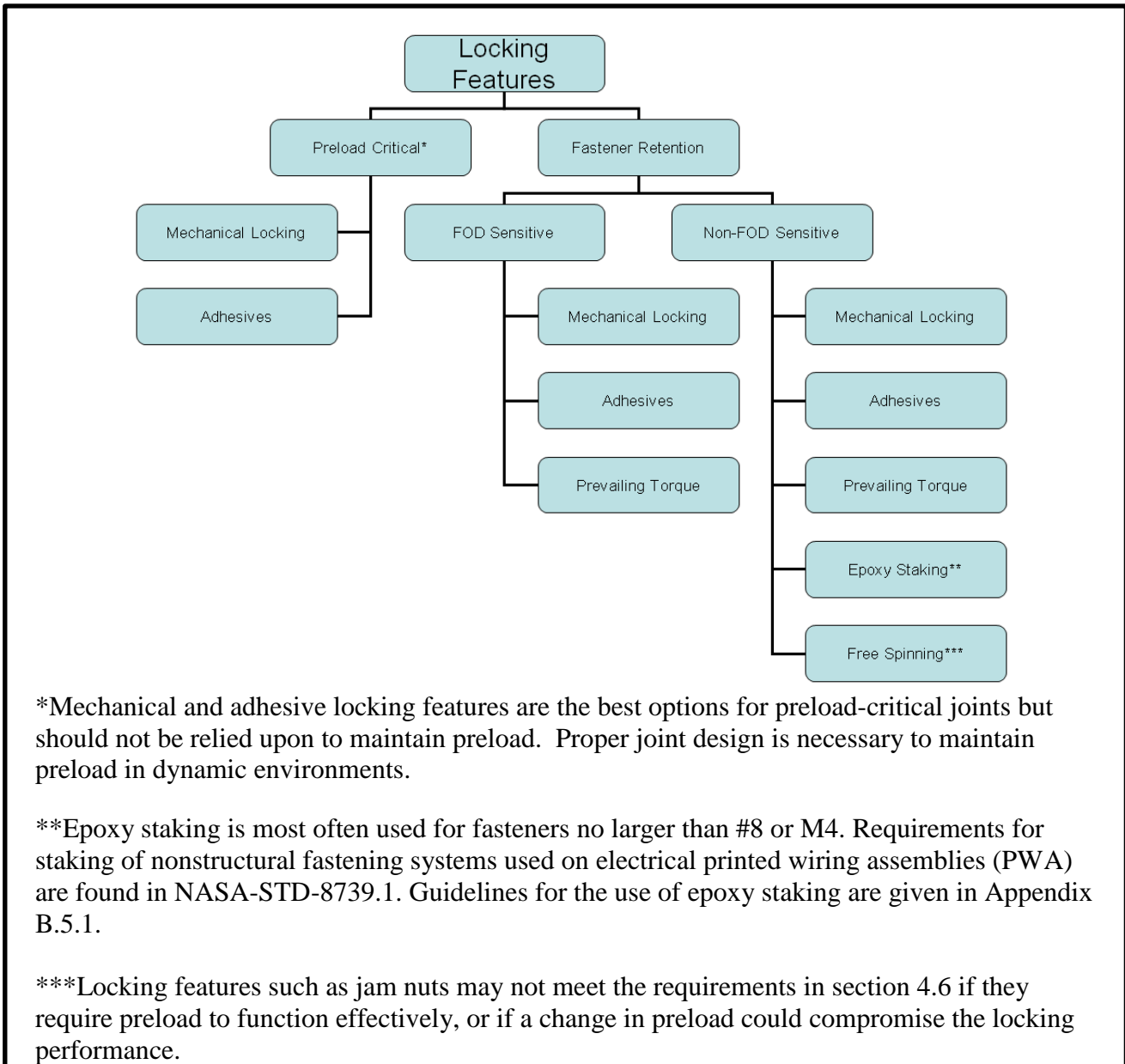

Figure 29—Locking Feature Selection Flowchart

B.4 Best Practices for Prevailing Torque Locking Features

B.4.1 General

a. Compared to fasteners with no secondary locking feature, prevailing torque locking devices can prevent complete separation of a fastening system after preload is lost. Due to the interference introduced by prevailing torque locking devices, they will help reduce the rate at which preload is lost.

NASA-STD-5020B

b. In severe vibration and shock environments, the main feature of prevailing torque locking devices is to prevent complete separation and loss of fasteners, not to maintain preload.

c. Where inserts will be reused, the locking feature should be on the more easily inspected and replaced externally threaded fastener. To minimize the potential for damage due to installation, the mating components should be selected to be compatible with each other.

B.4.2 Prevailing Torque Locking Devices

B.4.2.1 Self-Locking Nuts

a. Self-locking nuts are nuts with a locking feature resulting from a deformed (e.g., to an elliptical shape), undersized portion of the threads or incorporating nonmetallic (polymeric) insert. The locking feature can also be provided by a non-metallic (such as nylon) element that protrudes from the nut internal threads. The locking feature can be verified by measuring running torque.

b. NASM 25027, Nut, Self-Locking, 250 Degrees F, 450 Degrees F, and 800 Degrees F; and NAS 3350, Nuts, Self-Locking, 450 Degrees F and 800 Degrees F, High Quality, are the *performance* specifications for self-locking nuts. These include maximum locking (prevailing) torque and minimum breakaway torque values. NASM 25027 covers metal nuts with non-metal and metal locking features. NAS 3350 covers nuts with all all-metal locking features.

c. The unseated cycle life of 15 cycles required for qualification by NASM 25027 and NAS 3350 should not be assumed for seated cycle life. No seated cycle life requirement exists. Seating the bolt will affect the locking torque and the number of locking cycles. The extent of the effect is dependent upon materials of construction, lubrication, and preload.

d. Usage limitations are provided in NASM 33588, Nut, Self-Locking, Aircraft, Reliability and Maintainability Usage Requirements For. Examples include the following:

- (1) Not using self-locking nuts on an axis of rotation.
- (2) Ensuring external thread extends at least two threads through nut.
- (3) Not using silver-plated nuts with silver-plated bolts. Temperature limitations for nonmetallic locking features are provided in NASM 25027.

e. Examples of self-locking nuts are as follows:

- (1) NAS 1291, Nut, Self-Locking, Hexagon – Low Height, Light Weight.
- (2) NASM 21043, Nut, Self-Locking, 800 Degrees F, Reduced Hexagon, Reduced Height, Ring Base, Corrosion Resistant Steel.

APPROVED FOR PUBLIC RELEASE – DISTRIBUTION IS UNLIMITED

NASA-STD-5020B

- (3) NASM 21045, Nut, Self-Locking Hexagon – Regular Height, 450 Degrees F, 125 ksi Ft_u.
- (4) NASM 21046, Nut, Self-Locking, Hexagon - Regular Height, 800 Degrees F, 125 ksi Ft_u.

B.4.2.2 Self-Locking Nut Plates

- a. Self-locking nut plates use the same locking features as self-locking nuts.
- b. Examples of self-locking nut plates are NAS 1068, Nut, Self-Locking Plate, Two Lug, Low Height, C'bored, Floating, Reduced Rivet Spacing; and NAS 1773, Nut, Self-Locking, Plate, Two Lug, Low Height, C´Bored, Floating, 160 ksi, 450 Degrees F, 800 Degrees F; and NAS 1774, Nut, Self-Locking, Plate, One Lug, Low Height, C´Bored, Floating, 160 ksi, 450 Degrees F, 800 Degrees F.

B.4.2.3 Self-Locking Bolts with Nonmetallic Locking Feature

- a. Self-locking bolts are bolts with a locking feature resulting from a polymer plug, pellet, strip, or patch.
- b. Vibra-TITE[®] is pre-applied and dried before installation with no bonding between mating threads and is therefore not considered an adhesive. Performance characteristics per MIL-DTL-18240, Fastener Element, Self-Locking, Threaded Fastener, 250 °F Maximum, could be used.
- c. MIL-DTL-18240 is the specification for locking bolts up to 121°C (250°F) (temperature limit due to polymer locking material). This specification includes maximum and minimum running torque values.
- d. A seated cycle life of five cycles is required for qualification by MIL-DTL-18240.
- e. Usage limitations are given in NAS 15981, Fasteners, Externally Threaded, Self-Locking Design and Usage Limitations, and are similar to those given for locknuts in NASM 33588.
- f. Examples of fasteners that can be purchased as self-locking are as follows:
 - (1) NAS 6703–NAS 6720, Bolt, Tension, Hex Head, Close Tolerance, A286 CRES, Long Thread, Reduced Major Thread Diameter, Self-Locking and Nonlocking, 160 ksi Ft_u.
 - (2) NAS 8100–NAS 8106, Screw, Pan Head, Cruciform Recess, A-286 CRES, Full Thread, Self-Locking and Non Locking.

APPROVED FOR PUBLIC RELEASE – DISTRIBUTION IS UNLIMITED

NASA-STD-5020B

- (3) NAS 1189, Screw, Self-Locking, Flat 100 Degree Head, Cruciform and Offset Cruciform Recess, Full Thread.
- (4) NAS 1351, Screw, Cap, Socket Head, Undrilled and Drilled, Plain and Self-Locking, Alloy Steel, Corrosion-Resistant Steel and Heat-Resistant Steel, UNRF-3A.

B.4.2.4 Self-Locking Helical-Coil Inserts

- a. Self-locking helical-coil inserts are coils of wire (e.g., diamond-shaped wire). They are installed in a tapped parent metal hole with a special tool and are slightly oversized to create a frictional interlocking. The locking feature is provided by a deformed or undersized portion of the coil (e.g., hex shape for one thread) that creates a running torque.
- b. NASM 8846, Inserts, Screw-Thread, Helical Coil, is the specification for self-locking helical coils. This includes maximum locking (prevailing) torque and minimum breakaway torque values.
- c. The unseated cycle life of 15 cycles required for qualification by NASM 8846 should not be assumed for seated cycle life. No seated cycle life requirement exists. Seating the bolt will affect the locking torque and the number of locking cycles. The extent of the effect is dependent upon materials of construction, lubrication, and preload.
- d. HeliCoil[®] Technical Bulletin 68-2, provides comprehensive data on pullout strength for a range of available insert lengths and parent material shear strength.
- e. It is common practice to “wet install” helical-coils in aluminum structure to prevent galvanic corrosion between a corrosion-resistant steel (CRES) insert and an aluminum structure. Primers such as those conforming to MIL-PRF-23377, Primer Coatings: Epoxy, High-Solids, should be applied to the insert/base metal interface. Excess primer may migrate to areas contacting the installed fastener and affect torque.
- f. In general, helical coils are easier to replace than key locked inserts. However, if not installed correctly, helical coils have the potential to back out when subjected to high vibrations.

B.4.2.5 Self-Locking Key Locked-In Inserts

- a. Key locked-in inserts have integrally assembled keys on the outer diameter that stake (i.e., mechanically lock) the inserts inside a parent metal hole. The locking feature in a self-locking key locked-in insert is a deformed or undersized portion of the internal threads that creates a running torque.
- b. MIL-I-45914, Insert, Screw Thread – Locked In, Key Locked, General Specification For, is the specification for key locked-in inserts.

APPROVED FOR PUBLIC RELEASE – DISTRIBUTION IS UNLIMITED

NASA-STD-5020B

c. The unseated cycle life of 15 cycles required for qualification by MIL-I-45914 should not be assumed for seated cycle life. No seated cycle life requirement exists. Seating the bolt will affect the locking torque and the number of locking cycles. The extent of the effect is dependent upon materials of construction, lubrication, and preload.

d. Heavy-duty and extra-heavy-duty key locked-in inserts provide more pullout resistance than thin-wall locked-in inserts and helical-coil inserts of the same length. MIL-I-45914 provides data on pullout required for qualification.

e. Key locked-in inserts are solid walled so that application of corrosion prevention primer is not as problematic as with helical-coil inserts.

f. Typical examples of key locked-in inserts are MS 51830, Insert, Screw - Thread, Locked in, Key-Locked, Miniature and Lightweight Insert, Screw - Thread, Locked in, Key-Locked, Miniature and Lightweight; MS 51831, Insert, Screw-Thread, Locked in, Key Locked, Heavy Duty and MS 51832, Insert, Screw-Thread, Locked In, Key-Locked, Extra Heavy Duty.

B.4.2.6 Self-Locking Thin-Wall, Locked-In Inserts

a. Thin-wall, locked-in inserts are solid inserts that have a cylindrical shoulder at the top that is swaged into the parent metal with a special swaging tool. Swaging locks the insert into the hole and inhibits torque-out. The locking feature in self-locking thin-wall locked-in inserts is a deformed or undersized portion of the internal threads that creates a running torque on the fastener.

b. MIL-I-45932, Insert, Screw Thread, Thin Wall, Locked In, General Specification For, is the specification for thin-wall locked-in inserts.

c. The unseated cycle life of 15 cycles required for qualification by MIL-I-45932 should not be assumed for seated cycle life. No seated cycle life requirement exists. Seating the bolt will affect the locking torque and the number of locking cycles. The extent of the effect is dependent upon materials of construction, lubrication, and preload.

d. Thin-wall inserts are useful in joints that require less edge distance compared to key locked-in inserts that require larger edge distance to prevent shear tear-out.

B.4.3 Inspect

a. Parts are to be inspected. (See section 4.8.5.)

b. Prevailing torque locking devices are generally used "as-received" from manufacturing. Wipe away any visible loose particles and contaminants but do not clean with solvents.

APPROVED FOR PUBLIC RELEASE – DISTRIBUTION IS UNLIMITED

NASA-STD-5020B

B.4.4 Installation and Verification

- a. Verify the prevailing torque locking device meets the appropriate specification, such as:
 - (1) NASM 25027 and NAS 3350 for self-locking nuts and nut plates.
 - (2) MIL-DTL-18240 for self-locking bolts.
 - (3) NASM 8846 for self-locking helical-coil inserts.
 - (4) MIL-I-45914 for self-locking key locked-in inserts.
 - (5) MIL-I-45932 for self-locking thin-wall locked-in inserts.
- b. Finger assemble up to locking feature.
- c. Assemble two full turns further.
- d. Once locking feature is fully engaged, measure breakaway torque (torque to start motion in the on or off direction) and running torque.
- e. Should have at least one full turn left before fastener starts to seat.
- f. Verify measured torque (either breakaway or prevailing) is greater than the minimum breakaway torque required in the appropriate qualification specification.
- g. If both measured torques are within specification, then seat and tighten fastener to tightening torque, which is the sum of the preload torque required for desired preload plus the running torque.
- h. Record the applied torque, preload torque, running torque, locking device part number, and lot number.

B.5 Best Practices for Adhesive Locking Features

B.5.1 Adhesives

- a. Anaerobic
 - (1) Anaerobic adhesives (e.g., Loctite[®]) are single component thread-locking compounds that cure in the absence of air. They are applied to the threads of a fastener just prior to installation and then cure in place between the mating threads. The locking feature results from filling the clearance between mating threads and preventing relative slip.

APPROVED FOR PUBLIC RELEASE – DISTRIBUTION IS UNLIMITED

NASA-STD-5020B

- (2) MIL-S-22473, Sealing, Locking, and Retaining Compounds: (Single Component); MIL-S-46163, Sealing, Lubricating and Wicking Compounds: Thread-Locking, Anaerobic, Single-Component; and ASTM D5363, Standard Specification for Anaerobic Single-Component Adhesives (AN). However, MIL-S-22473 and MIL-S-46163 have been cancelled, so ASTM D5363 should be used.
- (3) Detailed process steps should be followed including surface preparation, cleaning, and primer application.
- (4) Typical design goals include selecting adhesive such that the break-loose torque is equal to or greater than the installation torque, and to meet prevailing torque device specification requirements when repairing worn-out, prevailing-torque locking features.
- (5) Examples of anaerobic adhesives include Loctite[®] 222, removable grade for up to 6.35-mm (0.25-in) screws; Loctite[®] 242, removable grade for up to 19.05-mm (0.75-in) bolts; and Loctite[®] 262, permanent grade for up to 19.05-mm (0.75-in) bolts.
- (6) Caution: When using anaerobic adhesives in blind holes, if adhesive is applied to the fastener or upper hole threads, entrapment of air in the hole and threads may prevent proper cure or push the adhesive out of the threads, leaving insufficient adhesive for locking. As a mitigation, some adhesive suppliers are recommending to only apply adhesive in the bottom of the blind hole. A development test may be necessary to ensure the resultant breakaway strength meets the desired minimum.

b. Epoxy and Staking Compounds

- (1) These materials are used by applying a small amount of the compound onto both the fastener (usually the head) and the surrounding structure such that when cured, the adhesive bond to both fastener and structure prevents rotation of (stakes) the fastener. This method is often used in electronic assemblies where a lost fastener is captive within the assembly and cannot adversely affect the function of other components. Requirements for staking of nonstructural fastening systems used on electrical printed wiring assemblies (PWA) are found in NASA-STD-8739.1. Staking methods are also sometimes used to secure fine-adjustment screws in position. Since adhesives are most susceptible to failure in peel, staking is considered a low-reliability locking feature. Epoxy and staking compounds are typically two-part materials requiring mixing before use.
- (2) Detailed process steps should be followed, including surface preparation and cleaning, mixing components of compound, and application.

APPROVED FOR PUBLIC RELEASE – DISTRIBUTION IS UNLIMITED

NASA-STD-5020B

- (3) Epoxy and staking compounds used in sensitive applications such as fluid wetted components, optical systems, and some external spacecraft surfaces can result in system contamination and performance degradation. Use of these materials should be considered for system-level contamination effects during design.

c. Other

- (1) Polyurethanes such as Arathane® and Solithane® that cure with or without residual oxygen remain gummy when cured and, in some instances, have been found to be effective even with residual lubricant on threads (HST-TR-010334, 2008).
- (2) Compounds such as Vibra-TITE® that are pre-applied and dried without curing before installation and with no bonding between mating threads are not considered adhesives and should not be used in safety-critical applications.

B.5.2 Process Validation

a. Acquire test verification specimens, as follows:

- (1) Obtain at least five representative or witness fastener specimens (e.g., bolts, nuts, inserts, washers) of the same material, size, finish, part number, and lot number as used in intended application.
- (2) Obtain representative clamped components of the same materials, finishes, clamping thickness, hole size, and tolerances. Parts of smaller size than clamped component in application are acceptable as long as the stiffness is comparable (e.g., cylinders).
- (3) Record part and lot numbers of specimens and description of clamped components.

b. Inspect and clean (see Appendices B.5.3 and B.5.4), as follows:

- (1) Visually inspect and verify that fastener components (e.g., bolts, nuts, washers, inserts, etc.) are free of damage. Discard damaged components.
- (2) Clean external threads and internal threads but not the bearing surfaces of the fastener specimens (e.g., bolt, nut, and washers) in the same manner as is used in the intended application (e.g., using cloth, wipes, or swabs dampened with appropriate solvent such as acetone or methyl ethyl ketone (MEK)). If bearing surfaces must be cleaned, bearing surface lubrication may be necessary to prevent galling.

APPROVED FOR PUBLIC RELEASE – DISTRIBUTION IS UNLIMITED

NASA-STD-5020B

- (3) Inspect and verify that the cleaned internal and external threads of test verification specimens are dry and free of residue, loose particles, and contamination as in intended application.
- c. Prime, as follows:
- (1) For epoxy staking applications, apply one coat of primer to bonding surfaces.
 - (2) For anaerobic adhesive applications, apply one coat of primer (e.g., Loctite[®] Primer, grade T or N) to the internal threads and external threads of the specimens as in intended application.
 - (3) Apply primer by spray, brush, or swab and allow primer to dry for 15 minutes minimum or up to 5 days maximum, as in intended application.
 - (4) Record primer part number (or grade), lot number, expiration date, and application date and time.
- d. Apply adhesive, torque, and cure, as follows:
- (1) Prepare adhesive as specified by manufacturer (e.g., for epoxy adhesive, mix resin and hardener; for anaerobic adhesive, shake bottle).
 - (2) Apply adhesive to both external and internal threads, 360 degrees around and over the complete thread engagement area, as in application.
 - (3) Assemble representative fastener specimens and clamped components to torque specified in application.
 - (4) Record adhesive part number (or grade), lot number, expiration date, and application date and time.
 - (5) Allow to cure for cure time (e.g., 24 or 48 hours) specified in application.
- e. Validation test, as follows:
- (1) Measure and record break loose torque (off direction) for each specimen.
 - (2) Measure and record removal running torque for each specimen.
 - (3) Depending upon design goal, (a) verify that the measured break loose torque (off direction) is greater than or equal to the installation torque; or (b) verify the running torque meets prevailing torque device specification requirements.
 - (4) Verify adhesive has fully cured by inspection.

APPROVED FOR PUBLIC RELEASE – DISTRIBUTION IS UNLIMITED

NASA-STD-5020B

B.5.3 Inspect

- a. Parts are to be inspected. (See section 4.8.5.)
- b. Discard damaged components.

B.5.4 Clean

a. Clean external threads and internal threads but not the bearing surfaces of the fastener specimens (e.g., bolt, nut, and washers) in the same manner as is used in the intended application (e.g., using cloth, wipes, or swabs dampened with appropriate solvent, such as acetone or MEK). If bearing surfaces must be cleaned, bearing surface lubrication may be necessary to prevent galling.

b. Inspect and verify that the cleaned threads are dry and free of residue, loose particles, or contamination.

B.5.5 Prime (for anaerobic adhesives only)

a. Use primer on inactive metals (e.g., aluminum, stainless steel, titanium, anodized, cadmium plated, and zinc plated).

b. Apply one coat of primer to both the internal and external threads by spray, brush, or swab.

c. Allow primer to dry for 15 minutes minimum.

d. Primed parts may be stored for up to 5 days maximum in sealed plastic bags. If not used within 5 days, re-clean and re-prime parts.

e. Record primer part number (or grade), lot number, expiration date, and application date and time.

B.5.6 Installation

a. Verify adhesive is within shelf life.

b. Prepare adhesive as specified by manufacturer (e.g., for epoxy adhesive, mix resin and hardener; for anaerobic adhesive, shake bottle).

c. Apply adhesive to internal and external threads, 360 degrees around and over the complete thread engagement area for blind holes. Apply adhesive to external threads, 360 degrees around and over the complete thread engagement area for through-hole assemblies. Ensure adhesive does not contact bearing surfaces.

APPROVED FOR PUBLIC RELEASE – DISTRIBUTION IS UNLIMITED

NASA-STD-5020B

- d. Assemble within 5 minutes to specified torque.
- e. Wipe excess adhesive from parts.
- f. Record adhesive part number (or grade), lot number, expiration date, and application date and time.
- g. Allow to cure for cure time (e.g., 24 or 48 hours) specified by manufacturer or engineering.

B.5.7 Verification

- a. Verify by using processes outlined in the process validation section (see Appendix B.5.2) using a coupon method.
- b. Five samples/coupons per configuration are required and need to be verified for each locking compound batch and technician.
- c. Inspect adhesive to ensure full cure.

B.5.8 General

- a. Cleaning and adhesives alter nut factor as follows:
 - (1) Cleaning process removes residual lubricant from components (e.g., bolts, nuts, inserts, washers, etc.). Either be extremely careful not to remove residual lubricant from bearing surfaces or use lubricant between bearing surfaces of similar material (e.g., stainless steel bolt head and washer) to prevent galling.
 - (2) Use the same cleaning, priming, adhesive application, and bearing surface treatment in the intended application as in the torque-tension tests used to obtain nut factor if preload is determined by torque measurement.
- b. Inadequate cleaning and priming of threads can lead to poor locking performance of adhesives.
- c. With adequate cleaning and priming of threads, adhesives can prevent loosening and maintain preload better than prevailing torque locking devices and mechanical locking devices in severe vibration and shock environments.
- d. Although adhesives are an appealing locking feature when an original prevailing torque locking feature has worn out, they are not a simple “quick fix.” The detailed process and verification steps of Appendix B.5 should be followed.

APPROVED FOR PUBLIC RELEASE – DISTRIBUTION IS UNLIMITED

B.6 Best Practices for Free Spinning

a. The mechanism of locking for free spinning locking devices is dependent on preload. Because of this dependence on preload, free spinning locking devices cannot be used as a secondary locking feature if preload is used for primary locking.

b. Free-spinning locking devices with serrated bearing surfaces perform well compared to other locking devices; however, their function is dependent on preload (see above).

c. Free-spinning locking devices with serrated bearing surfaces can damage joint bearing surfaces that can lead to crack formation and fatigue failure.

d. Free spinning split lock washers provide minimal, if any, locking. Air Force-Navy Aeronautical Design (AND) 10476 standard, Washer – Limitations on Usage of Lock, limits the use of lock washers to situations when other locking features cannot be used and when loosening would not endanger the safety of structure or personnel.

e. Split lock washers should not be used for secondary locking features.

APPENDIX C

JUSTIFICATION FOR LOW LIKELIHOOD OF FATIGUE FAILURE

C.1 Purpose of Appendix C

This Appendix provides information related to determining whether a fastener may have a low likelihood of fatigue failure and be verified by similarity to a known fastening system design.

C.2 Justification

A fastening system is considered similar if all of the following are true:

- The design service load spectrum is enveloped by the hypothetical design load spectrum shown in Table 7, Hypothetical Enveloped Applied-Loading Spectrum for Fastener Fatigue, and
- The fastener is made of A-286 alloy, and
- The fastener has UNJ or MJ threads rolled after heat treatment and the limit tensile load multiplied by any factors applicable to fatigue analysis does not exceed 50 percent of the fastener's allowable ultimate tensile load, or the fastener has UNR threads rolled after heat treatment and the limit tensile load multiplied by any factors applicable to fatigue analysis does not exceed 40 percent of the fastener's allowable ultimate tensile load, and
- The lowest elastic modulus for the material of any clamped part excluding washers is greater than one-third of the elastic modulus for the bolt material (see discussion in Appendix A.5), and
- The minimum edge distance (measured from center of hole to closest edge of any clamped part other than washers) is at least 1.5 times the bolt diameter (see discussion in Appendix A.5), and
- Requirement TFSR 10 (see section 4.4.3) is satisfied, and
- If threads are in the shear plane, either a dedicated shear transfer device such as a shear pin or dowel pin is present or analysis per the requirements of section 4.4.6 demonstrates no slipping occurs.

NASA-STD-5020B

Table 7—Hypothetical Enveloped Applied-Loading Spectrum for Fastener Fatigue

Applied load as a percentage of limit load	Vibration Test	Flight	Total	Design (4x)
10%	4752	259	5011	20045
20%	13038	651	13689	54756
30%	18176	760	18935	75741
40%	19464	624	20088	80351
50%	17507	390	17897	71588
60%	13689	199	13889	55555
70%	9466	81	9547	38189
80%	5845	27	5872	23486
90%	3241	7	3249	12995
100%	2821	2	2822	11290
Total cycles	108000	3000	110999	443996
Assumptions: <ul style="list-style-type: none"> • The bolt is loaded highest by random-vibration response of a 200-Hz mode of vibration. • The flight structural assembly is proto-flight tested for 1 minute per axis, 3 dB above maximum predicted environment, at three levels of assembly, for a total of 3 minutes per axis. • The 200-Hz mode is excited equally by all three axes of excitation (conservative assumption). • Random vibration is at or near maximum predicted environment for 15 seconds during launch. • The loading spectra for test and launch are based on a Rayleigh distribution. • Limit load for proto-flight-level random vibration is 3-sigma (three times the root-mean-squared value) and is set equal to $0.5P_{tu-allow}$. • All loading cycles above 3-sigma from the Rayleigh distribution are included in the cycles at 100 percent limit load. • The number of cycles at each load increment includes a service life factor of 4. 				

The similarity criteria is based on fatigue analysis using data acquired in tensile fatigue testing of 160-ksi, A-286, NAS1351N fasteners and a hypothetical loading spectrum intended to be worst case for single-mission spaceflight hardware. The NAS1351N fastener is a socket-head cap screw with a UNR thread form that has a specified root radius and is thus more fatigue resistant than the UN and M thread forms but is not as fatigue resistant as the UNJ and MJ thread forms that have a larger specified root radius. Thus, any conclusions drawn from fatigue analysis using this test data are conservative for A-286 fasteners with rolled UNJ or MJ threads.

The fatigue tests were conducted on two sizes of fasteners, 0.1900-32 UNRF (0.190-in diameter) and 0.3750-24 UNRF (0.375-in diameter). The smaller fasteners were from three lots, each from

APPROVED FOR PUBLIC RELEASE – DISTRIBUTION IS UNLIMITED

NASA-STD-5020B

a different supplier, whereas the larger diameter fasteners were from a single lot. Three fasteners were tested from each lot for each of eleven combinations of maximum load and stress ratio, R , that is defined as the minimum applied load within a loading cycle divided by the maximum applied load within that cycle. Each fastener was cycled within its given load parameters until rupture or until one million cycles were reached, whichever occurred first.

S-N curves were used to assess fastener fatigue life for a joint and a loading spectrum that together are intended to represent a worst-case scenario for single-mission flight hardware. The joint assessed is the one shown in Figure 10, for which, prior to separation, the bolt's tensile load increases by a high percentage of applied relative to most joints. The loading spectrum used in the fatigue analysis is shown in Table 7. Each level of applied load is assumed to be fully reversed (tensile and compressive).

To assess the bolt in the subject joint for fatigue life, the applied-loading spectrum is transformed into two bolt-loading spectra. One spectrum is based on the assumption of a high preload, equal to $0.75P_{tu-allow}$, and the other spectrum is based on the assumption of a low preload, equal to $0.5P_{tu-allow}$ that is the lowest the preload could be for the separation criteria to be met with a limit load equal to $0.5P_{tu-allow}$. For each level of applied load, the total bolt load is calculated using Eq. 8. For fully reversed applied load, as assumed in this study, Eq. 8 is conservatively assumed to apply for compressive loading as well as for tensile loading, such that the mean load is equal to the preload.

Miner's rule was used in this study as the failure criterion

$$D = \sum_{i=1}^j \frac{n_i}{N_i} \leq 1 \quad (\text{Eq. 87})$$

where D is the cumulative damage, n_i is the number of loading cycles at a given stress level, N_i is the number of cycles to failure at that stress level, and j is the number of different stress levels.

Table 8, Results of Fastener Fatigue Analysis for the Hypothetical Joint and Loading Spectra, shows the results of the fatigue analyses where the stress ratios were calculated using nonlinear finite element analysis. With both loading spectra, the Miner's rule criterion passes.

UNR thread form. Although the study justifies a limit tensile load as high as $0.5P_{tu-allow}$, a limit tensile load of only $0.4P_{tu-allow}$ is allowed for fasteners having the UNR thread form. This apparent discrepancy is intentional as a result of uncertainty, given the limited fatigue data used in the analysis and the assumptions made in the analysis. The UNJ and MJ thread forms have larger root radii than UNR and thus have better fatigue life. Given this fact along with the lack of fatigue data for A-286 fasteners with UNJ or MJ threads, a limit tensile load of $0.5P_{tu-allow}$ is allowed for fasteners having UNJ or MJ threads based on the results of the above analysis.

NASA-STD-5020B

Table 8— Results of Fastener Fatigue Analysis for the Hypothetical Joint and Loading Spectra

Max load is normalized to the allowable ultimate tensile load, $P_{tu-allow}$.				
Case 1: High preload				
Design cycles, ni (4x)	Max load	Stress ratio, R	Allowable cycles, Ni	ni/Ni
20052	0.754	0.99	1000000	0.020
54760	0.756	0.98	1000000	0.055
75744	0.759	0.98	1000000	0.076
80356	0.762	0.97	1000000	0.080
71592	0.765	0.96	1000000	0.072
55560	0.771	0.95	1000000	0.056
38196	0.775	0.94	1000000	0.038
23492	0.782	0.92	1000000	0.023
13000	0.791	0.90	1000000	0.013
11292	0.800	0.88	125000	0.090
444044			D =	0.523
				PASS

Case 2: Low preload				
Design cycles, ni (4x)	Max load	Stress ratio, R	Allowable cycles, Ni	ni/Ni
20052	0.504	0.99	1000000	0.020
54760	0.506	0.98	1000000	0.055
75744	0.509	0.96	1000000	0.076
80356	0.514	0.95	1000000	0.080
71592	0.520	0.92	1000000	0.072
55560	0.527	0.90	800000	0.069
38196	0.539	0.86	750000	0.051
23492	0.552	0.81	700000	0.034
13000	0.568	0.76	400000	0.033
11292	0.585	0.71	200000	0.056
444044			D =	0.545
				PASS

The hardware developer should determine whether their particular loading spectrum is enveloped by the spectrum used in this analysis.

This analysis shows that, for a fastener meeting all of the stipulations for similarity, fatigue under tensile loading is not a concern for the above hypothetical loading spectrum. The test data used in this study are from testing of NAS1351N fasteners that have the UNR thread form.

APPROVED FOR PUBLIC RELEASE – DISTRIBUTION IS UNLIMITED

APPENDIX D

REFERENCES

D.1 Purpose of Appendix D

This Appendix provides guidance through the reference documents listed below.

D.2 Reference Documents

Document Number	Document Title
	HeliCoil® Technical Bulletin 68-2 (Emhart Teknologies, Shelton, Connecticut)
	Hahn, Gerald J.; Shapiro, Samuel S. (1967). <i>Statistical Models in Engineering</i> . New York: John Wiley & Sons, Inc.
	Hess, D. P. "Threaded Fastener Secondary Locking Requirements." <i>Journal of Failure Analysis and Prevention</i> , Volume 17, Number 4
	Nassar, S. A.; Ganganala, M. "Effect of Separating Load Eccentricity on the Clamp Load Loss in a Bolted Joint Using a Strain Hardening Model." <i>ASME Journal of Pressure Vessel Technology</i> . (Reviewed and accepted manuscript #PVT-09-1060.)
	Odeh, Robert E.; Owen D. B. (1980). <i>Tables for Normal Tolerance Limits, Sampling Plans and Screening</i> . New York: Marcel Dekker, Inc.
	Spiegel, Murray R. (1961). <i>Schaum's Outline of Theory and Problems of Statistics</i> . New York: McGraw-Hill Book Company
	Stronge, William James; Yu, Tongxi. (1993). <i>Dynamic Models for Structural Plasticity</i> . London, Great Britain: Springer-Verlag
AND 10476	Washer – Limitations on Usage of Lock

NASA-STD-5020B

Document Number	Document Title
ASME B18.12-2001	Glossary of Terms for Mechanical Fasteners
ASTM D5363-03	Standard Specification for Anaerobic Single-Component Adhesives (AN)
FAA AC 20-71	Dual Locking Devices on Fasteners
FAA AC 23.607-1	Self-Locking Nuts on Bolts Subject to Rotation
FED-STD-H28	Screw-Thread Standards for Federal Services
HST-TR-010334	Cooper, James. (August 4, 2008). <i>Arathane Thread Locking Vibration Test Report</i> . Greenbelt, MD: NASA Goddard Space Flight Center.
JSC-28918	EVA Design Requirements and Considerations
MIL-DTL-18240	Fastener Element, Self-Locking, Threaded Fastener, 250° F Maximum
MIL-HDBK-60	Threaded Fasteners-Tightening to Proper Tension
MIL-I-45914	Insert, Screw Thread – Locked In, Key Locked, General Specification For
MIL-I-45932	Insert, Screw Thread, Thin Wall, Locked In, General Specification For
MIL-PRF-23377	Primer Coatings: Epoxy, High-Solids
MIL-S-22473E (Cancelled. Future acquisitions for this item may refer to ASTM-D5363. Users are cautioned to evaluate replacements for their particular application.)	Sealing, Locking, and Retaining Compounds: (Single Component)
MIL-S-46163A (Superseded by ASTM-D5363)	Sealing, Lubricating and Wicking Compounds: Thread-Locking, Anaerobic, Single-Component

APPROVED FOR PUBLIC RELEASE – DISTRIBUTION IS UNLIMITED

NASA-STD-5020B

Document Number	Document Title
MS 51830	Insert, Screw - Thread, Locked in, Key-Locked, Miniature and Lightweight
MS 51831	Insert, Screw - Thread, Locked in, Key-Locked, Miniature and Lightweight Insert, Screw - Thread, Locked in, Key-Locked, Miniature and Lightweight
MS 51832	Insert, Screw-Thread, Locked In, Key-Locked, Extra Heavy Duty
NAS 618	Fastener – Recommended Shank, Hole, and Head-to-shank Fillet Radius Limits For
NAS 1068 (Not for New Design)	Nut, Self-Locking Plate, Two Lug, Low Height, C'Bored, Floating, Reduced Rivet Spacing
NAS 1189	Screw, Self-Locking, Flat 100 Degree Head, Cruciform and Offset Cruciform Recess, Full Thread
NAS 1291	Nut, Self-Locking, Hexagon – Low Height, Light Weight
NAS 1351	Screw, Cap, Socket Head, Undrilled and Drilled, Plain and Self-Locking, Alloy Steel, Corrosion-Resistant Steel and Heat-Resistant Steel, UNRF-3A
NAS 1773	Nut, Self-Locking, Plate, Two Lug, Low Height, C'Bored, Floating, 160 ksi, 450 Degrees F, 800 Degrees F
NAS 1774	Nut, Self-Locking, Plate, One Lug, Low Height, C'Bored, Floating, 160 ksi, 450 Degrees F, 800 Degrees F
NAS 1956	Bolt, Shear, Hexagon Head, 108 ksi Shear, Long Thread
NAS 3350	Nuts, Self-Locking, 450 Degrees F and 800 Degrees F, High Quality

APPROVED FOR PUBLIC RELEASE – DISTRIBUTION IS UNLIMITED

NASA-STD-5020B

Document Number	Document Title
NAS 6703–NAS 6720	Bolt, Tension, Hex Head, Close Tolerance, A286 CRES, Long Thread, Reduced Major Thread Diameter, Self-Locking and Nonlocking, 160 ksi Ft _u
NAS 8100-NAS 8106	Screw, Pan Head, Cruciform Recess, A-286 CRES, Full Thread, Self-Locking and Non Locking
NAS 15981	Fasteners, Externally Threaded, Self-Locking Design and Usage Limitations
NASA-STD-5001	Structural Design and Test Factors of Safety for Spaceflight Hardware
NASA-STD-5005	Standard for the Design and Fabrication of Ground Support Equipment
NASA-STD-5019	Fracture Control Requirements for Spaceflight Hardware
NASA-STD-8739.1	Workmanship Standard for Polymeric Application on Electronic Assemblies
NASA TM-108377	The Mechanism of Bolt Loading
NASA/TM-2012-217454	Aerospace Threaded Fastener Strength in Combined Shear and Tension Loading
NASM 8846	Inserts, Screw-Thread, Helical Coil
NASM 21043	Nut, Self-Locking, 800 Degrees F, Reduced Hexagon, Reduced Height, Ring Base, Corrosion Resistant Steel
NASM 21045	Nut, Self-Locking Hexagon – Regular Height, 450 Degrees F, 125 ksi Ft _u
NASM 21046	Nut, Self-Locking, Hexagon - Regular Height, 800 Degrees F, 125 ksi Ft _u
NASM 25027	Nut, Self-Locking, 250 Degrees F, 450 Degrees F, and 800 Degrees F

APPROVED FOR PUBLIC RELEASE – DISTRIBUTION IS UNLIMITED

NASA-STD-5020B

Document Number	Document Title
NASM 33540	Safety Wiring, Safety Cabling, Cotter Pinning, General Practices for
NASM 33588	Nut, Self-Locking, Aircraft, Reliability and Maintainability Usage Requirements For
NSTS 08307	Criteria for Preloaded Bolts, NASA Johnson Space Center, Revision A, July 6, 1998
SAE AIR 1754A	Washer, Thermal Compensating, Metric Series
SAE AS567K	Safety Cable, Safety Wire, Key Washers, and Cotter Pins for Propulsion Systems, General Practices for Use of
VDI 2230	“Systematic Calculation of High Duty Bolted Joints, Joints with One Cylindrical Bolt.” (February 2003). Düsseldorf, Germany: Verein Deutscher Ingenieur.

APPROVED FOR PUBLIC RELEASE – DISTRIBUTION IS UNLIMITED

NASA-STD-5020B

APPENDIX E

REQUIREMENTS COMPLIANCE MATRIX

E.1 Purpose of Appendix E

Due to the complexity and uniqueness of space flight, it is unlikely that all of the requirements in a NASA technical standard will apply. The Requirements Compliance Matrix below contains this NASA Technical Standard's technical authority requirements and may be used by programs and projects to indicate requirements that are applicable or not applicable to help minimize costs. Enter "Yes" in the "Applicable" column if the requirement is applicable to the program or project or "No" if the requirement is not applicable to the program or project. The "Comments" column may be used to provide specific instructions on how to apply the requirement or to specify proposed tailoring.

NASA-STD-5020B				
Section	Description	Requirement in this Standard	Applicable (Enter Yes or No)	Comments
4.1	Fastening System Control Plan	<p>[TFSR 1] At the Preliminary Requirements Review, equivalent program milestone review, or project milestone review, each hardware developer shall submit a Fastening System Control Plan to the delegated NASA Technical Authority that:</p> <ul style="list-style-type: none">a. Shows how the requirements in this NASA Technical Standard are to be satisfied; andb. Includes any organization-specific requirements and criteria for design, analysis, fastener installation, and verification; andc. Captures or refers to organization-specific processes for ensuring quality and integrity.		
4.2.1	Factor of Safety	<p>[TFSR 2] Threaded fastening system hardware shall be designed using the structural factors of safety specified by the program or project for general structural design.</p>		

APPROVED FOR PUBLIC RELEASE – DISTRIBUTION IS UNLIMITED

NASA-STD-5020B

NASA-STD-5020B				
Section	Description	Requirement in this Standard	Applicable (Enter Yes or No)	Comments
4.2.2	Fitting Factor	[TFSR 3] Threaded fastening system hardware shall be designed using a fitting factor (FF).		
4.2.3	Separation Factor of Safety	<p>[TFSR 4] Threaded fastening system hardware shall be designed using the separation factor of safety (FS_{sep}) specified by Figure 1, Logic Flow for Minimum Separation Factor of Safety.</p> <div style="text-align: center;"> <pre> graph TD A[Could joint separation credibly lead to a catastrophic hazard? (1)] -- YES --> B[FS_sep = program levied value for FS_u] A -- NO --> C[Could joint separation credibly lead to a critical hazard? (2)] C -- YES --> D[FS_sep = greater of 1.2 and program levied value for FS_y] C -- NO --> E[FS_sep = greater of 1.0 and program levied value for test factor (3)] </pre> </div> <p>(1)A hazard that could result in a mishap causing fatal injury to personnel, and/or loss of one or more major elements of the flight vehicle or ground facility. A condition that may cause death or permanently disabling injury, major system or facility destruction on the ground, or loss of crew, major systems, or vehicle during the mission. (2)A condition that may cause severe injury or occupational illness, or major property damage to facilities, systems, or flight hardware. (3)If testing, such as proof or acceptance, is to be performed at higher than limit load, the factor should be increased to envelope test conditions to preclude separation during test.</p> <p style="text-align: center;">Figure 1—Logic Flow for Minimum Separation Factor of Safety</p>		
4.3.1	Maximum and Minimum Preload	[TFSR 5] Maximum and minimum preload calculations shall account for the preload variation associated with the method of developing initial preload, potential relaxation, creep, and the effects of maximum and minimum expected temperatures.		
4.3.2	Nominal Preload	[TFSR 6] Calculation of the nominal (mean) initial preload, P_{pi-nom} , shall be substantiated by tests of a minimum of six sets of the fastening system hardware per Table 2, Nominal Preload Determination, to determine the relationship between initial preload and the parameter controlled during installation (torque, turn-of-nut, turn-angle, or bolt stretch).		

APPROVED FOR PUBLIC RELEASE – DISTRIBUTION IS UNLIMITED

NASA-STD-5020B

NASA-STD-5020B						
Section	Description	Requirement in this Standard			Applicable (Enter Yes or No)	Comments
Table 2—Nominal Preload Determination						
		Torque Control ^(1,2)	Turn-of-Nut or Turn-Angle	Bolt Stretch		
The fastening system hardware has the same diameter and thread form, the same type and number of washers, same materials, and same nut/nut plate/insert as the flight assembly. The clamped part and washer that are adjacent to a non-rotating bolt head or non-rotating nut are not critical and are allowed to vary from the flight assembly.		R	R	R		
Cleaning, lubricants, and lubrication process are the same as flight assembly.		R	R	NR		
The fastening system hardware is the same specification (part number) as the flight assembly hardware.		NR	R	R		
Installation process is the same as flight assembly.		NR	R	R		
R=Required, NR=Desirable but not required ⁽¹⁾ At least three tests (install, torque, and removal) should be performed on each of the six sets of fastening system hardware for a total of eighteen tests, unless reuse is prohibited in the flight assembly. ⁽²⁾ See NASM 1312-15, Fastener Test Methods, Method 15, Torque-Tension, for guidance for torque-tension testing.						
4.3.3	Preload Variation	[TFSR 7] The preload variation, I , used to calculate the minimum and maximum initial preload shall be based on the criteria of Table 3, Preload Variation Determination.				

APPROVED FOR PUBLIC RELEASE – DISTRIBUTION IS UNLIMITED

NASA-STD-5020B

NASA-STD-5020B				
Section	Description	Requirement in this Standard	Applicable (Enter Yes or No)	Comments
Table 3 – Preload Variation Determination				
Method	Separation Critical	Non-Separation Critical		
Torque Control	Envelope of statistical basis ⁽¹⁾ and variation to satisfy Table 2 ⁽²⁾ while using a. Lot-specific testing (testing the procurement lot of fastening system hardware that will be used for spaceflight) ⁽³⁾ or b. Testing equal numbers of sets of fastening system hardware of the same specification as the flight-assembly hardware, from each of at least three procurement lots ⁽³⁾	a. Statistical basis ⁽¹⁾ , or b. Greater of (1) 25 percent (if lubricated), (2) 35 percent (if non-lubricated or as-received), (3) Variation from tests to satisfy Table 2 ⁽²⁾		
Turn-of-Nut or Turn Angle	Envelope of statistical basis ⁽¹⁾ and variation to satisfy Table 2 ⁽²⁾	a. Statistical basis ⁽¹⁾ , or b. Greater of (1) 25 percent (2) Variation from tests to satisfy Table 2 ⁽²⁾		
Bolt Stretch	Envelope of statistical basis ⁽¹⁾ and variation to satisfy Table 2 ⁽²⁾	a. Statistical basis ⁽¹⁾ , or b. Greater of (1) 10 percent (2) Variation from tests to satisfy Table 2 ⁽²⁾		

APPROVED FOR PUBLIC RELEASE – DISTRIBUTION IS UNLIMITED

NASA-STD-5020B

NASA-STD-5020B				
Section	Description	Requirement in this Standard	Applicable (Enter Yes or No)	Comments
		<p>⁽¹⁾90 percent probability and 95 percent confidence (two-sided distribution), with tests meeting the configuration requirements of Table 2.</p> <p>⁽²⁾The variation from the tests to satisfy Table 2 is given by the minimum and maximum values of preload relative to the nominal preload such that $\Gamma_{a-max} = P_{pi-max} / P_{pi-nom} - 1$ and $\Gamma_{a-min} = 1 - P_{pi-min} / P_{pi-nom}$.</p> <p>⁽³⁾Each fastener to be installed, torqued, and removed at least three times unless reuse is prohibited for the flight assembly. When reuse is prohibited, only the data from the first cycle is used.</p>		
4.4.1	Ultimate Design Loads	<p>[TFSR 8] Threaded fastening system hardware shall withstand ultimate design loads (limit load times the ultimate factor of safety and fitting factor) without failure when subjected to:</p> <ul style="list-style-type: none"> a. The accompanying service environments (for example, temperature) and b. A coefficient of friction between clamped parts equal to zero (applicable only to verification by analysis, not applicable to verification by test) [see TFSR 13]. 		
4.4.2	Yield Design Loads	<p>[TFSR 9] Threaded fastening system hardware shall withstand yield design loads (limit load times the yield factor of safety and fitting factor) without detrimental yielding or detrimental deformation when subjected to the accompanying service environments (for example, temperature).</p>		
4.4.3	Separation Loads	<p>[TFSR 10] Threaded fastening system hardware shall withstand design separation loads (limit load times the separation factor of safety and fitting factor) without loss of compression between the joint members or detrimental deformation due to separation when subjected to the accompanying service environments (for example, temperature).</p>		
4.4.4	Combination of Loads	<p>[TFSR 11] The limit, yield, ultimate, and separation loads shall account for interaction of the combined loading (simultaneously applied tensile, shear, and bending loads) and under all design environmental conditions.</p>		
4.4.5	Inclusion of Preload in Yield and Ultimate Load Strength	<p>[TFSR 12] If rupture occurs before separation, preload shall be included in the determination of the total tensile load in the preloaded bolt.</p>		

APPROVED FOR PUBLIC RELEASE – DISTRIBUTION IS UNLIMITED

NASA-STD-5020B

NASA-STD-5020B				
Section	Description	Requirement in this Standard	Applicable (Enter Yes or No)	Comments
4.4.6a	Use of Friction at Limit and Yield Load	[TFSR 13] Use of friction to react shear loads shall only be permissible for analysis at limit load (alignment, fatigue, and fracture) or yield load.		
4.4.6b	Use of Friction at Limit and Yield Load	[TFSR 14] Unless otherwise substantiated by test, the coefficient of friction for joint-slip analysis shall be no greater than: (1) 0.20 for uncoated, non-lubricated metal surfaces that are cleaned by a qualified process and visibly clean at and after assembly. (2) 0.10 for all other surfaces, including nonmetallic (coated or uncoated) surfaces and metallic surfaces that are coated with any substance, including lubricant, paint, and conversion coating.		
4.5	Fatigue Life	[TFSR 15] All threaded fastening systems shall be designed to withstand the entire service life, including the life scatter factor specified by the program or project, and service environment without fatigue failure.		
4.6.1	Preload Independent Locking Feature	[TFSR 16] Regardless of the magnitude of preload, each threaded fastening system in spaceflight hardware shall incorporate a minimum of one locking feature that does not depend upon preload to function.		
4.6.2	Mechanical Locking Feature	[TFSR 17] A mechanical locking feature shall be used on any bolt subject to rotation in operation.		
4.6.3	Liquid Locking Compound Process Control	[TFSR 18] When using locking adhesives, whether as thread-locking compounds or staking materials, installation processes shall be developed and validated prior to implementation to ensure adhesives cure, adhere, and function as expected.		
4.6.4	Locking Feature Verification	[TFSR 19] The presence and performance (locking moment) of locking features shall be verified using the methods of Table 4, Locking Feature Torque Verification.		
Table 4—Locking Feature Torque Verification				
Locking Feature Type		Method		
Mechanical <i>(including, but not limited to, cotter pins, safety wire, and safety cable)</i>		Visual inspection after installation		

APPROVED FOR PUBLIC RELEASE – DISTRIBUTION IS UNLIMITED

NASA-STD-5020B

NASA-STD-5020B				
Section	Description	Requirement in this Standard	Applicable (Enter Yes or No)	Comments
	<p>Prevailing Torque <i>(including, but not limited to, deformed thread features and non-metallic pellets, strips, or patches)</i></p> <p>Liquid Locking Compounds <i>(including, but not limited to, adhesives, sealants, thread lockers, and chemical thread pre-coats that are applied to the threads and cured prior to joint assembly)</i></p>	<p>Torque measurement during installation⁽¹⁾</p> <p>Torque measurement on witness specimens using the same materials and processes, and processed at the same time, as the hardware being verified⁽²⁾</p>		
<p>⁽¹⁾Verification of prevailing torque locking features by torque measurement may be omitted with prior approval of the delegated NASA Technical Authority if loss of fastener does not credibly cause a catastrophic hazard and if other controls are utilized to minimize the likelihood of assembly with inadequate locking features. Examples of such controls are fastener lot acceptance testing of locking feature performance, locking feature surveillance with periodic measurement of prevailing torque on like fasteners in flight hardware assemblies, technician training to recognize when no prevailing torque is present, etc. The rationale for this approach needs to properly consider fastener reuse if fastener reuse is permitted in the flight assembly. Preloaded joint analyses cannot assume a specified torque ‘above running torque’ if prevailing torque is not measured. Relaxation of this verification requirement is generally intended for secondary or tertiary structures such as P-clamps.</p> <p>⁽²⁾For adhesive locking features that are not sensitive to the threaded fastening system materials or configuration, cure samples processed at the time of application/processing may be used for verification.</p>				
4.7.1	Materials	[TFSR 20] Materials used in threaded fastening systems shall comply with NASA-STD-6016, Standard Materials and Processes Requirements for Spacecraft.		
4.7.2	Thread Form Compatibility	[TFSR 21] Mating threaded parts shall have compatible thread forms.		
4.7.3	Use of Washers and Chamfered Bolt Holes	[TFSR 22] Clearance shall be provided for the head-to-shank fillet radius as needed to avoid interference with the clamped parts through the use of chamfered holes or countersunk washers installed under bolt heads with the countersink facing the bolt head (see Figure 2, Dimensional Considerations in Selecting Fastening Hardware).		

APPROVED FOR PUBLIC RELEASE – DISTRIBUTION IS UNLIMITED

NASA-STD-5020B

NASA-STD-5020B				
Section	Description	Requirement in this Standard	Applicable (Enter Yes or No)	Comments
		<p style="text-align: center;">Figure 2—Dimensional Considerations in Selecting Fastening Hardware</p>		
4.7.4	Fastener Length Selection for Thread Engagement	[TFSR 23] When the threaded fastening system incorporates a prevailing torque locking feature, the fastener length shall be sufficient for fully formed threads to engage the locking feature.		
4.7.5a	Bolt Grip Selection to Prevent Interference	[TFSR 24] For a fastener with a full diameter body, the bolt grip and the number and type of washers shall be selected to ensure the internal threads do not encroach on the incomplete runout threads of the fastener.		
4.7.5b	Bolt Grip Selection to Prevent Interference	[TFSR 25] Fasteners threaded into blind holes shall be selected to prevent contacting the bottom of the hole or interfering with incomplete internal threads.		
4.8.1	Design Documentation	[TFSR 26] The engineering documentation shall specify <ol style="list-style-type: none"> a. The part or identifying numbers of fastening system hardware, and b. Required lubricants, coatings, or sealants used in threaded fastening systems, the area to which they are applied, as well as their application processes, and c. Dimensions and tolerances necessary to manufacture and assemble the fastened joint and its constituent parts, and 		

APPROVED FOR PUBLIC RELEASE – DISTRIBUTION IS UNLIMITED

NASA-STD-5020B

NASA-STD-5020B				
Section	Description	Requirement in this Standard	Applicable (Enter Yes or No)	Comments
		d. The types, locations, and allowable quantities of washers, and e. The installation methods and parameters for achieving preload, and f. The installation torque range or applicable standard that defines the installation torque range, and g. Whether the specified torque is total torque or the torque above running torque.		
4.8.2	As-Built Documentation	[TFSR 27] Records documenting the as-built procedures and configuration of each assembly shall be created and maintained by the hardware developer and provided for review upon request by the delegated NASA Technical Authority.		
4.8.3	Training	[TFSR 28] Personnel installing fastening system hardware shall be trained per program-, project-, or organization-specific quality process.		
4.8.4a	Tools and Instruments	[TFSR 29] Tools and instruments used to install fastening system hardware shall be verified to be in calibration prior to use and used within their design and calibration ranges.		
4.8.4b	Tools and Instruments	[TFSR 30] Torque instruments shall conform to ASME B107.300-2010, Torque Instruments, or a NASA-approved alternative.		
4.8.5	Threaded Fastening System Hardware Inspection	[TFSR 31] Threaded fastening system hardware shall be inspected prior to installation to verify that part number(s), cleanliness, and orientation are in accordance with the engineering documentation.		
4.8.6	Fastening System Hardware Procurement, Inspection, and Storage	[TFSR 32] Procurement, receiving inspection, and storage of threaded fastening system hardware that joins or retains components or structural elements shall meet the requirements of NASA-STD-8739.14, NASA Fastener Procurement, Receiving Inspection, and Storage Practices for NASA Mission Hardware.		

APPROVED FOR PUBLIC RELEASE – DISTRIBUTION IS UNLIMITED